

THE RADIO REVIEW

A MONTHLY RECORD OF SCIENTIFIC
PROGRESS IN RADIOTELEGRAPHY
AND TELEPHONY

VOL. I

SEPTEMBER, 1920

No. 12

Editor :

PROFESSOR G. W. O. HOWE, D.Sc., M.I.E.E.

Assistant Editor :

PHILIP R. COURSEY, B.Sc., A.M.I.E.E.

CONTENTS.

Electron Tube Generators of Alternating Currents of Ultra-Radio
Frequencies G. C. SOUTHWORTH, M.S.

Everyday Measurement of Inductance and Capacity in the Wireless
Laboratory L. B. TURNER, M.A., M.I.E.E.

The Diffraction of the Field by a Cylinder and its Effect on Directive
Reception on Board a Ship . . . Commandant RENÉ MESNY

The Power required for Long Distance Transmission

THE EDITOR

Review of Radio Literature :

Abstracts of Articles and Patents

Book Reviews

Two Shillings and Sixpence Net

GENERAL LIBRARY
SEP 24 1920
UNIV. OF MICH.

THE RADIO REVIEW

VOL. I

SEPTEMBER, 1920

NO. 12

Electron Tube Generators of Alternating Currents of Ultra-Radio Frequencies.*

By G. C. SOUTHWORTH, M.S.

INTRODUCTION.

The electron tube amplifier when properly connected to a circuit containing inductance and capacity, will sustain continuous oscillations in that circuit. The tube merely provides the switching mechanism by which the energy from some source is used to maintain these oscillations. Its rôle is analogous to that of the escapement of a clock or the slide valve of a steam engine.

A general form of a generator circuit is shown in Fig. 1. The manner in which it operates may be explained briefly as follows: Variations in the plate current i_p , due to variations in the electron emission from the hot filament to the plate, cause a reactance drop across X_p . This institutes an E.M.F. in the oscillatory circuit $X_p X_o X_g$ which results in a current I_o . Variations in I_o create a reactance drop across X_g and impress a voltage on

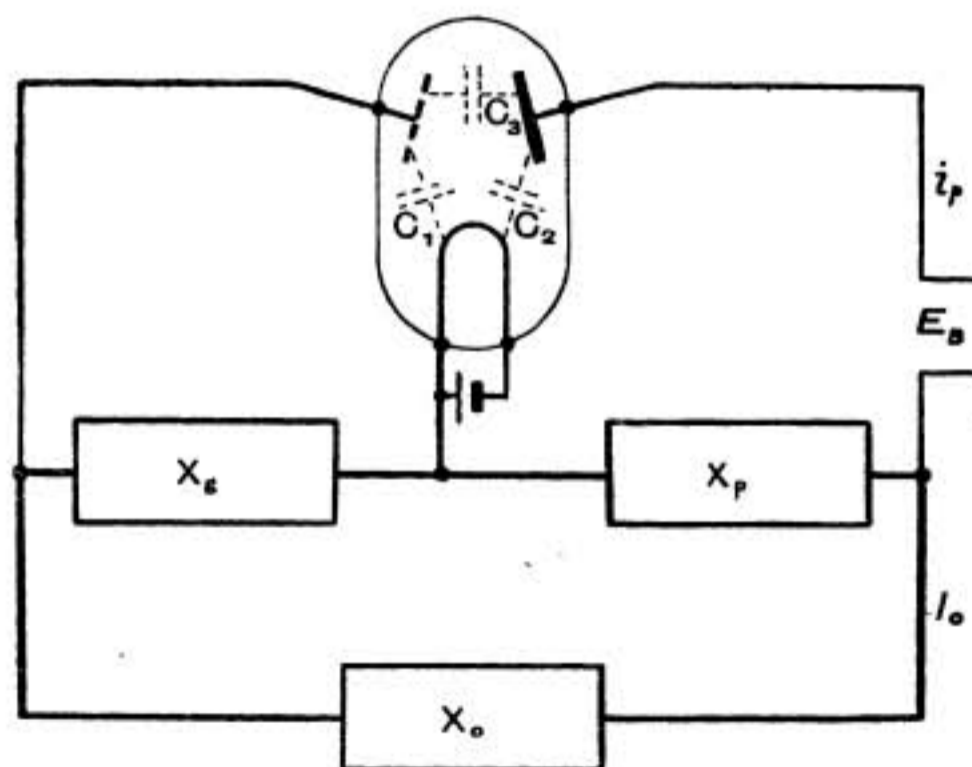

FIG. 1.—General form of Oscillating Circuit.

* Received April 30th, 1920.

22

the grid. The variable grid voltage in turn causes variations in the plate current. This provides the conditions for continuous oscillations assuming that the connections give the proper phase relations. The power supply for sustaining these oscillations comes from the battery in the plate circuit.

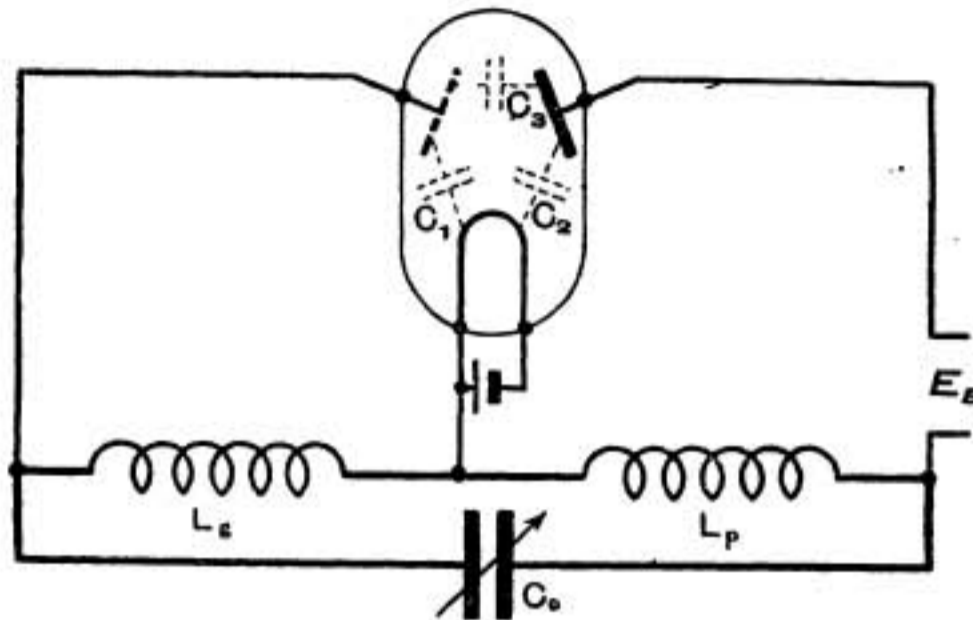

FIG. 2.—The "Hartley Circuit."

When X_p and X_g are inductive reactances and X_o is a capacitive reactance Fig. 1 reduces to the so-called "Hartley Circuit." If X_p and X_g are capacitive reactances and X_o is an inductive reactance, it reduces to the "Colpitt Circuit." In either case the frequency of oscillation is approximately that which makes $X_o + (X_p + X_g) = 0$.

APPLICATION TO THE HIGHER FREQUENCIES.

The electron tube generator is seldom used for frequencies higher than a few million cycles per second. Below this limit little difficulty is experienced, but at the higher frequencies difficulties of various kinds are encountered. The greatest of these are the necessarily small dimensions of the coils and condensers used, the uncertain distribution of the inductance and capacity

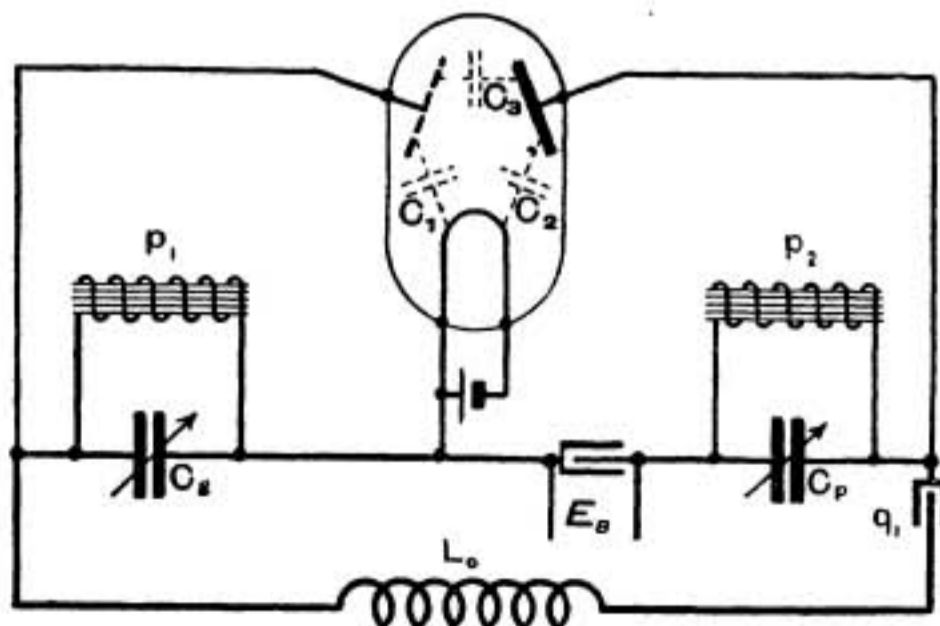

FIG. 3.—The "Colpitt Circuit."

of connecting wires and instruments, and the relatively large capacities that exist between the electrodes of the tube. In view of these difficulties it is obvious that the Hartley Circuit in the form shown in Fig. 2 is not adaptable to wavelengths shorter than perhaps 50 metres since the tube capacities C_1 , C_2 and C_3 may form circuits with the coupling inductances L_p and L_g whose natural periods limit the frequency and the power output.

The Colpitt Circuit which used capacitive reactances for coupling the tube to the circuit offers a great advantage inasmuch as the tube capacities do not ordinarily form resonant circuits with the coupling reactances. Its great disadvantage lies in the fact that numerous pieces of apparatus are required between which there may be extraneous capacities and weird coupling effects. The Colpitt connection in its usual form is shown in Fig. 3. The oscillatory circuit for the lower frequencies is indicated by the heavy lines. The choke p_2 completes the circuit for the direct current component of the plate current. The choke p_1 in conjunction with the large capacity q_1 serves to keep the grid and filament at approximately the same voltage. The design of the chokes is such as to make their reactance much greater than that due to C_g or C_p , and the natural period of the oscillatory circuit is not seriously altered by their presence. When all dimensions of this form of circuit are suitably reduced wavelengths as short as 20 metres may be obtained.

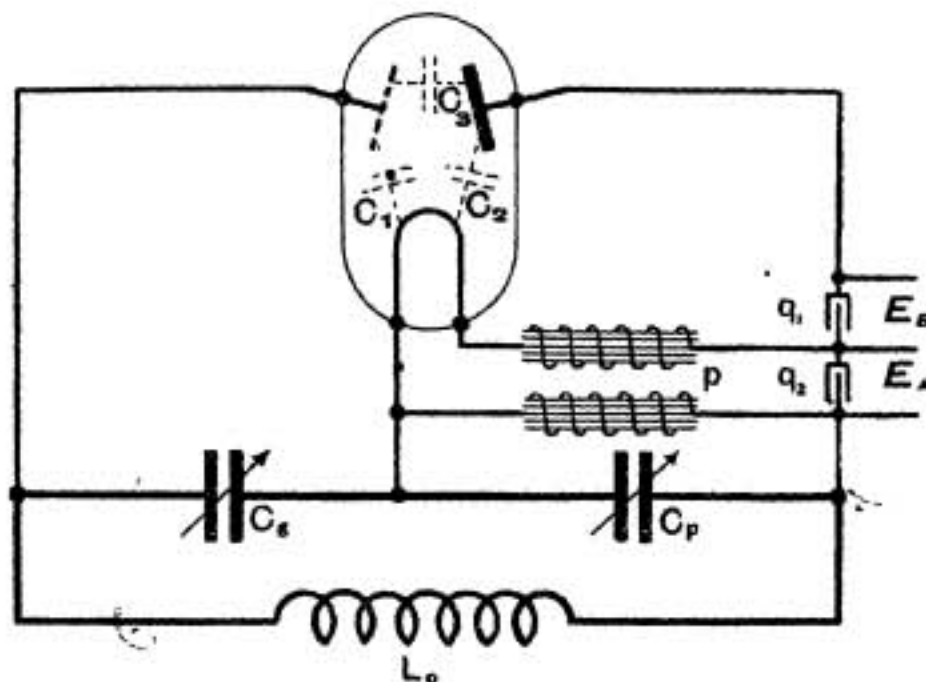

FIG. 4.—Modified Colpitt Circuit for High Frequencies.

The modification shown in Fig. 4 eliminates the choke between grid and filament. The choke p consists of double turns through which the filament current may be led. This simplification was found sufficient to reduce the wavelength to 10 metres.

CIRCUIT FOR PRODUCING VERY HIGH FREQUENCIES.

In order to produce wavelengths shorter than 10 metres it is necessary to substitute for the circuit having "lumped" inductance one having its inductance and capacity uniformly distributed.

It has been found that by this arrangement wavelengths considerably less than two metres may be obtained with the VT-2 tube. The circuit diagram is shown in Fig. 5. The author has departed somewhat from the conventional methods of drawing such diagrams, in order to show the relative location of the apparatus in the circuit. The oscillatory circuit is indicated by the heavy lines. Its frequency is determined by the dimensions of the rectangle, the capacity C and the capacity between the electrodes of the tube.

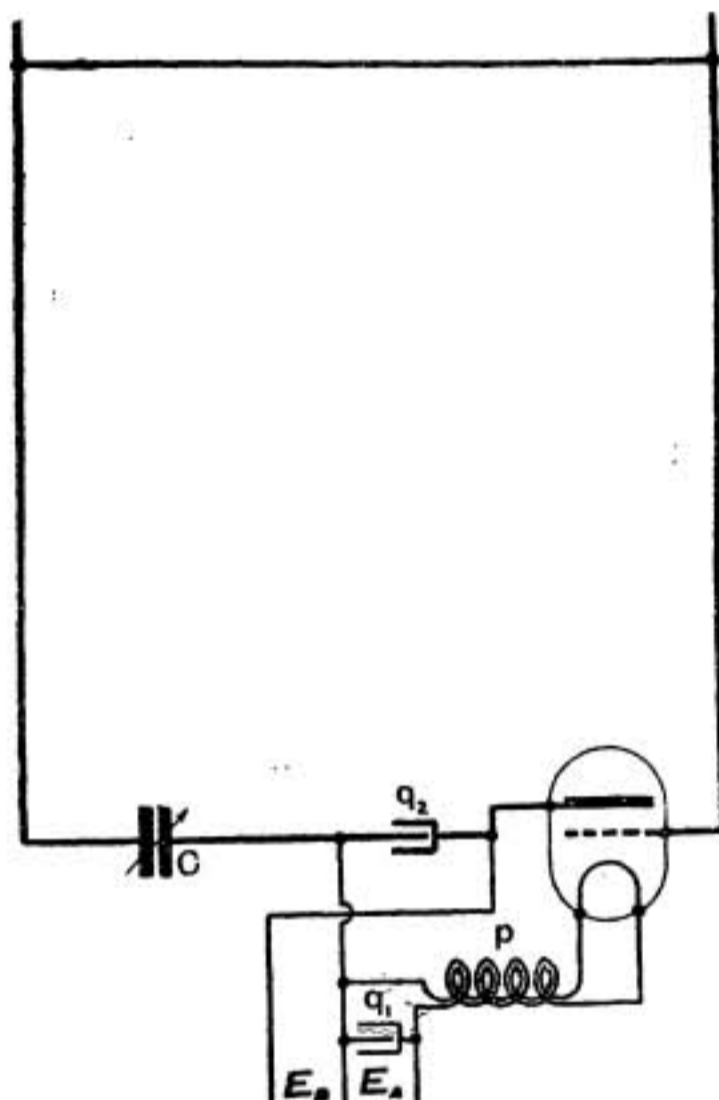

FIG. 5.—Circuit with Distributed Capacity and Inductance for generating Ultra-radio Frequencies.

The relative location of the apparatus in the circuit is of very great importance. The conductors through which the input is led, place three points of the circuit at earth potential. It is preferable therefore to locate these three points as close together as possible. Since the length of the rectangle is appreciable compared with the wavelength, waves are propagated along the rectangle and reflected at the ends. The ground imposed by the power leads may well be placed near the middle of the end of the rectangle. If the capacity of C is approximately equal to that of the tube, the voltage distribution along the two sides of the rectangle will be symmetrical. The wave front is therefore approximately perpendicular to the conductors forming the sides of the rectangle. This symmetrical condition may be

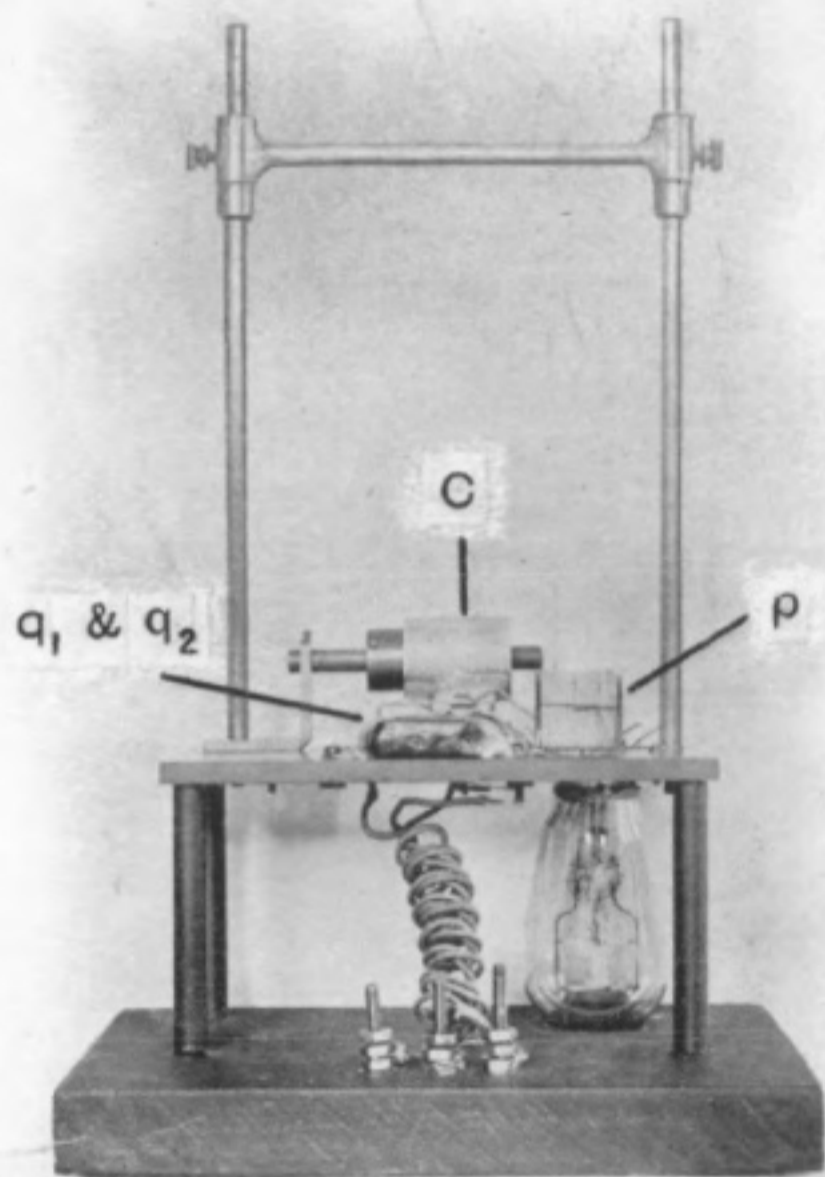

FIG. 6.

(To face p. 580.)

verified by grounding corresponding points on the opposite sides of the rectangle and observing the power output. A second point at earth potential will be observed near the middle of the closed end.

A generator which was found to oscillate well at the highest frequencies mentioned above is shown in Fig. 6. The rectangle which is 13 cm. in width is variable from 8 cm. to 21 cm. in length. The condenser C consists of two concentric cylinders 3.2 cm. long with diameters of 1.8 cm. and 2.5 cm. The choke p is made by winding 11 double turns of No. 24 magnet wire on a former 2.2 cm. square and 2.2 cm. long. The stopping condensers q_1 and q_2 are made up of alternate sheets of foil and mica each 2.5 cm. square. Enough are assembled to make a capacity of about 1500 $\mu\mu\text{F}$. The electron tube is the U.S. Army Type VT-12. The capacities between the electrodes are about 5 $\mu\mu\text{F}$. each after the base has been removed. Other circuits used for developing high frequencies are described in the articles mentioned below.*

WAVELENGTH CALIBRATION OF THE GENERATOR.

The most accurate way of determining the wavelength of the generator is to couple it to a parallel wire system and measure the length of the standing waves produced. The details of this method will be given later.

The curves of Fig. 7 are the values of the wavelength of the generator plotted against the length of the rectangle. The family of solid curves is the calibration when the type VT-2 tube is used, the dotted line curves are obtained when the VT-12 tube is used, and the broken line curves are obtained with the VT-14.† Each curve is a result of a different setting of the condenser C. The removal of the unused portions of the conductors increases the stability of the circuit and makes it possible to obtain wavelengths shorter than those indicated in Fig. 7. A minimum wavelength of 110 cms. has been obtained with the VT-14 tube. From the straight line characteristic of these curves it is obvious that the wavelength is approximately proportional to the length of the rectangle. This verifies statements previously made, concerning the distributed nature of the capacity and inductance.

One might expect that the oscillatory circuit having distributed constants would reinforce certain harmonics. A careful investigation involving two different methods failed to detect either even or odd harmonics. One of the methods used would have detected any harmonic, the amplitude of which was one-half of one per cent. of the fundamental. This would indicate that the wave produced was approximately sinusoidal.

The power input of the generator shown in Fig. 6 as measured by the

* W. C. White, "The Plotron Oscillator for Extreme Frequencies" (*General Electric Review*, 19, pp. 771—775, September, 1919). B. van der Pol, "The Production and Measurement of Short Continuous Electromagnetic Waves" (*Philosophical Magazine*, 38, pp. 90—97, July, 1919). C. Gutton and M. Touly, "Undamped Electric Oscillations of Short Wavelength" (*Comptes Rendus*, 168, pp. 271—274, February 3rd, 1919). Also *Revue Générale de l'Électricité*, March 15th, 1919.

† The VT-2, VT-12, and the VT-14 are types of power tubes used by the U.S. Army.

product of the plate current and plate voltage varies with the adjustment of the circuit from 10 watts to 30 watts. In the latter case of course the tube is greatly overloaded. Inasmuch as 15 watts may easily be dissipated without excessive heating of the plates, we may conclude that the tube is being operated under fairly favourable conditions.

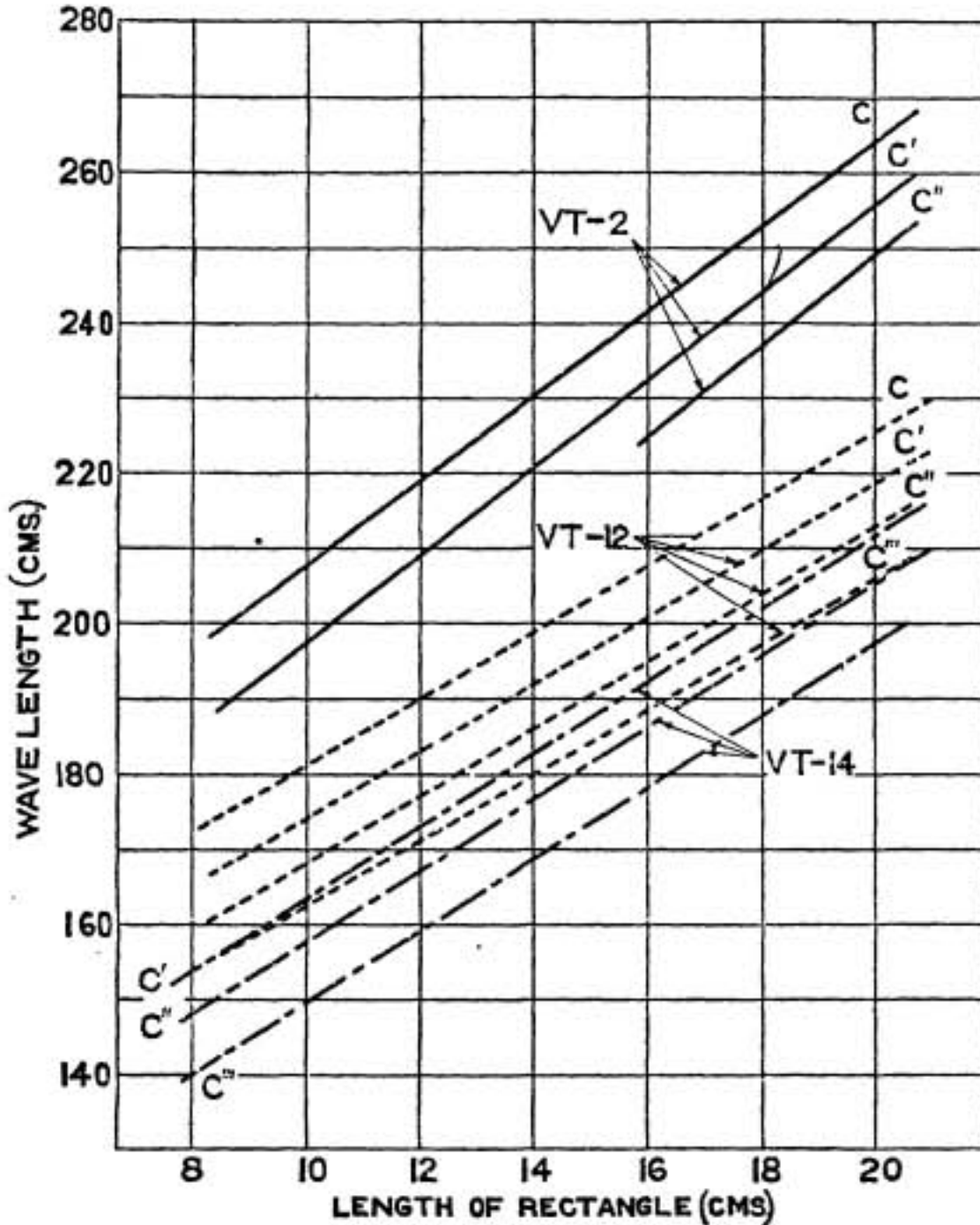

FIG. 7.—Calibration Curves for Electron Tube Generator of Ultra-radio Frequencies.

No satisfactory method is available for measuring currents at these high frequencies. In an early experimental circuit a shunted ammeter located in the oscillatory circuit indicated currents of 4 amperes. The nature of its shunt and the proximity of the meter case to other pieces of apparatus would indicate that the actual current was much greater than that read by the ammeter. It was also found that upon removing the meter the input was considerably reduced. This proved that the ammeter contributed an appreciable portion to the total losses.

The constancy of this generator is approximately the same as for the tube circuits used for lower frequencies providing it is properly shielded. It was found that the output was seriously affected by reflecting objects located in the plane of the rectangle. This was particularly noticeable when the generator was coupled to a parallel wire system. In this case the current in the parallel wire system would fluctuate several per cent. as a person approached the generator in a direction along the plane of the rectangle. This apparently caused conditions of interference by reflecting back a portion of the radiated energy. This effect was noticeable at distances equal to several wavelengths.

METHOD OF MEASURING WAVELENGTH.

The resonator on which the standing waves are produced and measured consists of two parallel wires 5 cm. apart, which terminate in plane reflectors. One of these reflectors is made in two parts connected by a cross wire thermocouple. The other terminals of the thermocouple lead to a sensitive galvanometer of low resistance. The extra lengths of wire necessary for making adjustments pass through a conducting plane over pulleys and support weights which keep the parallel wires taut. Springs make positive contact between the wires and the thermocouple. The shielding effect of the conducting plane prevents standing waves on the extra lengths of wires or the galvanometer leads. The thermocouple and two-piece reflector are insulated from the shield by means of thin mica. The end of the resonator to which the generator is coupled is supported by a post mounted on a sliding platform.

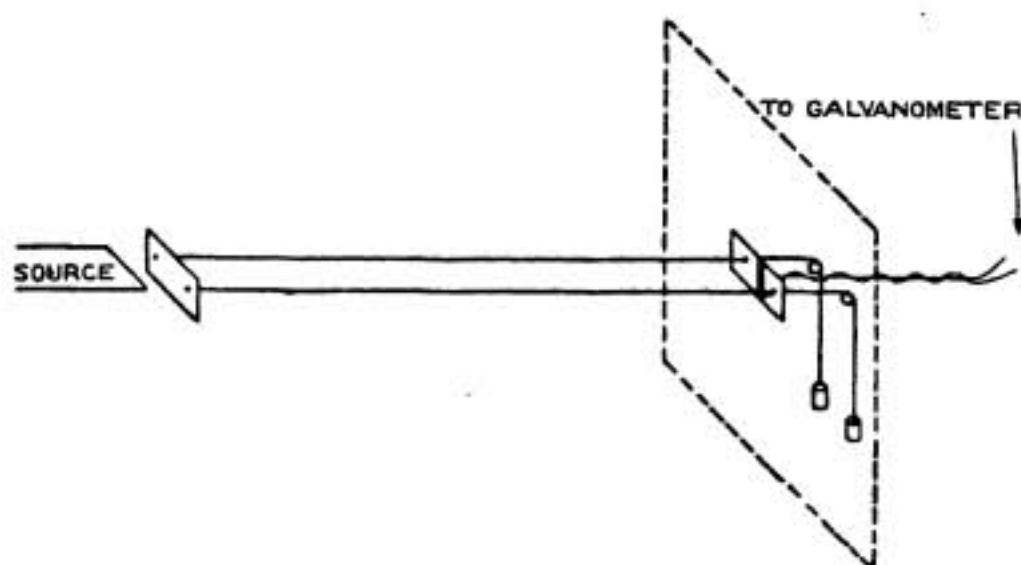

FIG. 8.—Arrangement of Apparatus for measuring Wavelength.

The generator being mounted on this platform enables the coupling to be kept constant while the conductors are being adjusted for length. A screw attached to the sliding platform permits an accurate adjustment of the lengths of the wires. The lengths are determined by a vernier attached to the platform which passes over a fixed scale. The arrangement of the generator and resonator is shown in Fig. 8.

A resonance curve plotted from corresponding readings of length of

resonator and galvanometer deflections is shown in Fig. 9. The sharpness of resonance as defined by the ratio of the fractional change in the current to the fractional change in the length of the conductors is approximately 260. The sharpness of resonance for many wavemeter circuits used in radio is 40. The sharpness of resonance could be increased considerably by choosing a thermocouple of lower resistance.

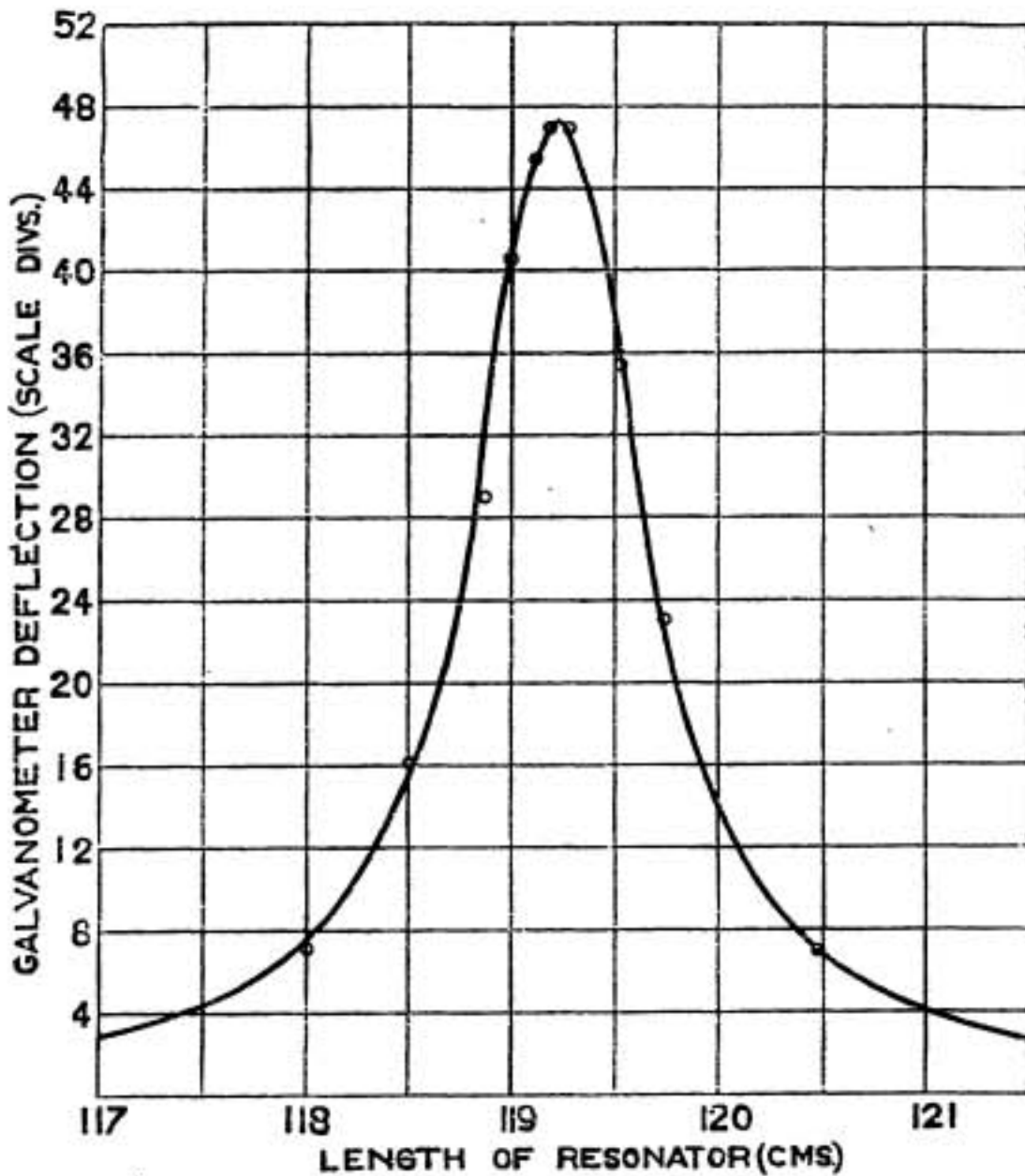

FIG. 9.—Resonance Curve.

The constancy of this type of generator and the degree of precision with which points of resonance may be determined make it especially adaptable to measurement purposes. Many of the corrections necessary when a damped source is used are eliminated. The applications of the electron tube to measurements at ultra-radio frequencies will be presented in a subsequent paper.

Yale University,
New Haven, Conn.

February 12th, 1920.

Everyday Measurement of Inductance and Capacity in the Wireless Laboratory.*

By L. B. TURNER, M.A., M.I.E.E.

"The most important step in the progress of every science is the measurement of quantities," said Clerk Maxwell; and this is almost as true in the work of designing wireless apparatus as in that wider field of scientific research into the unknown to which the quotation strictly refers. Every competent wireless experimentalist either possesses or feels the want of means to measure quickly and easily those two most important dimensions of his equipment, the inductance and capacity of his coils and condensers. The more pressing need is for ease and rapidity, rather than for great precision, of measurement; and while a cupboardful of calibrated and labelled inductance coils of various shapes and sizes is a valuable possession, facilities for measuring in a moment the inductance of any half-stripped winding he may be handling is of much greater worth.

Since a wavemeter is a necessity in all wireless experimental work, it frequently happens that laboratory measurements of inductance and capacity, when made, are made by a method of wavemeter resonance. With the modern triode substitute for the buzzer generator of oscillation, this method is capable of giving precise results; but it is often both inconvenient and inaccurate; inconvenient in that to cover the wide ranges of values involved, many interchangeable standard coils and condensers must be used; inaccurate because all such high-frequency measurements are subject to great errors arising from stray inductances and capacities (especially the latter) unless troublesome precautions are taken and corrections applied. On the other hand, by resorting to measurement at low frequency, the self-capacities of coils, and the inductances and capacities of connecting wires and fittings, become negligible; so that if apparatus sufficiently simple and easily adjusted can be devised a low-frequency method is much more convenient than the wavemeter method. Urged by an experience of the need and the difficulties referred to, the writer was moved to design the two instruments described below.† When installed (immovably) in his laboratory, they quickly came to be regarded as almost indispensable instruments, partly as mere time savers, but even more as conferring that freedom and confidence which can rest only on a knowledge of the dimensions of the circuits handled.

INDUCTANCE BRIDGE.

For measuring inductances, the bridge circuit ‡ shown in Fig. 1 was adopted; the supply across one diagonal of the bridge being an interrupted

* Received June 21st, 1920.

† They were designed and constructed at the Signals Experimental Establishment, Woolwich, and the writer is indebted to Lieut.-Colonel Cusins, C.M.G., R.E., for permission to reproduce the photographs.

‡ Due to D. Owen, *Electrician*, July 30th, 1915.

unidirectional current, and the detector across the other diagonal being an ordinary headgear telephone receiver. The conditions for balance are easily shown to be

$$(r_2 + r) \cdot C_2 = r_1 \cdot C_1 \quad \dots \dots \dots (1)$$

$$\text{and} \quad L = r_1 \cdot C_1 \cdot R \quad \dots \dots \dots (2)$$

These equations involve no frequency factor, so that the complications of a steady sinoidal generator of known frequency are avoided, and the much simpler device of a D.C. supply with buzzer interrupter is applicable.

In the bridge as constructed, r_1 and r_2 are made fixed resistances, and condition (1) is provided for by making C_2 a variable condenser. C_2 is referred to as the compensating condenser, being reduced in capacity to compensate for the resistance r of the inductance coil under test. The value of the inductance sought is given by condition (2), and is read off as the value of the external resistance R multiplied by the factor $r_1 C_1$. It is convenient to read R in ohms and to evaluate L in microhenries. We have then

$$L \text{ (microhenries)} = R \text{ (ohms)} \times M$$

where the multiplier M is the product of r_1 in ohms and C_1 in microfarads

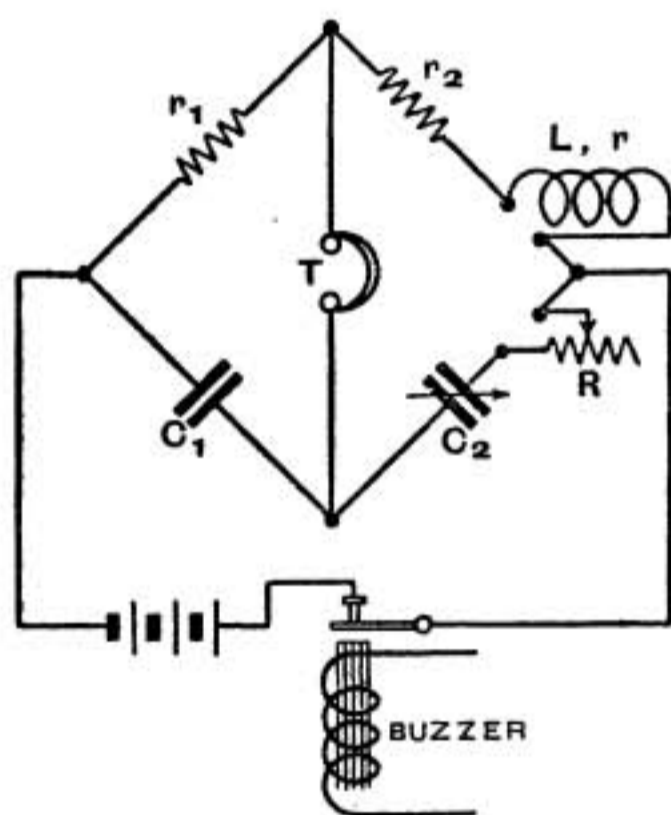

FIG. 1.—CONNECTION SCHEME OF INDUCTANCE BRIDGE.

For Balance: $(r_2 + r)C_2 = r_1 C_1$ and
 $L = r_1 C_1 R$.

non-reactive at the frequency employed. The internal resistances r_1 and r_2 are constructed of fine Eureka wire (S.W.G. 44) wound on thin ebonite plates; and it is possible to purchase (for R) the non-reactive resistance boxes used for telephonic measurements. But Table I. shows that the more ordinary bifilar bobbin resistances are good enough.

C_1 is made 0.0100 microfarad; r_1 (and r_2) can be plugged to any of the four values 1, 10, 100 or 1,000 ohms; so that M is made 0.01, 0.1, 1 or 10 at will. A photograph of the instrument, with lid removed, is shown in Fig. 2, the dimensions (with lid) being $10\frac{3}{4}$ ins. \times $6\frac{1}{4}$ ins. \times $5\frac{1}{2}$ ins. Fig. 3 gives the diagram of connections and instructions for use. The compensating condenser C_2 is uncalibrated; it is variable in mica steps by means of the six-stud switch, and continuously by an ebonite-air adjustable condenser connected in parallel.

With an external resistance box for R , preferably of decade dial pattern adjustable between 10 and 10,000 ohms in steps of 10 ohms, any inductance between one-tenth of a microhenry and one-tenth of a henry can be measured in a couple of minutes or so. All the resistances should, of course, be sensibly

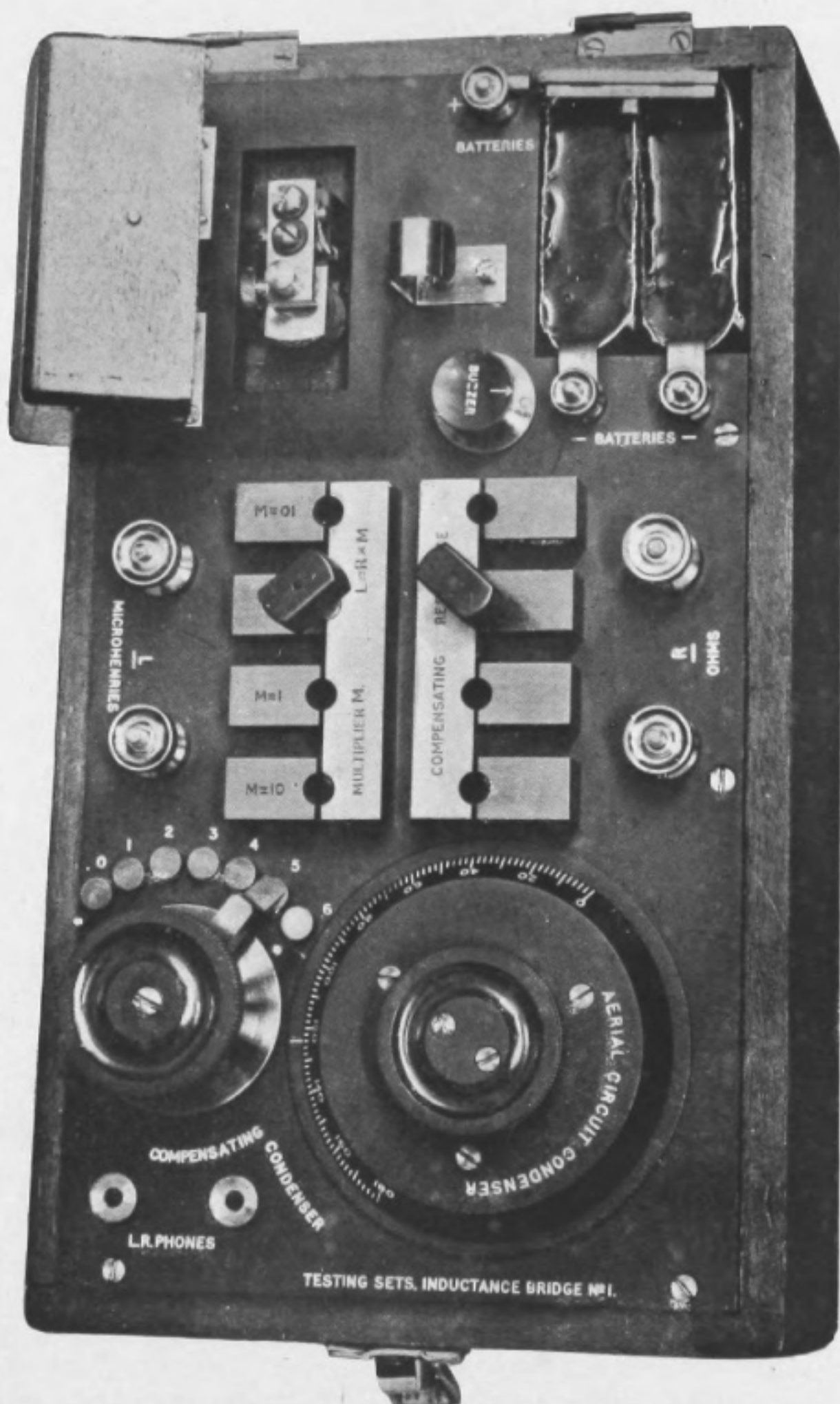
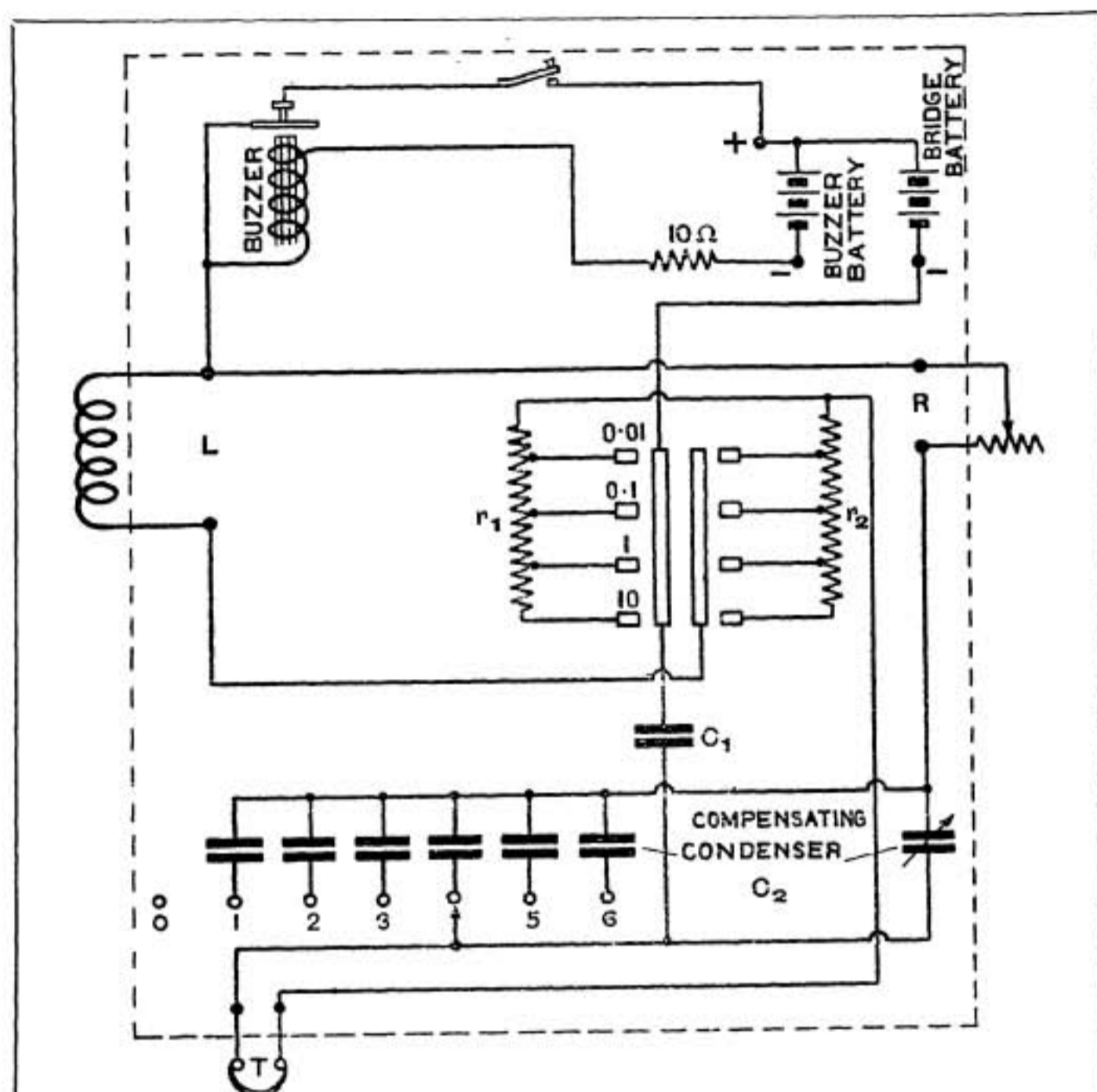

FIG. 2.—INDUCTANCE BRIDGE.

(To face page 586.)



$C_1 = 0.0100 \mu\text{F}$. $C_2 = C_1$ or less according to value of r . r_1 and r_2 are each 1, 10, 100, or 1,000 Ω according to position of plugs.

INSTRUCTIONS.

- (1) Join unknown inductance to terminals L and resistance box to terminals R.
- (2) Set both plugs to $M = 0.01, 0.1, 1$ or 10 according as L is below 100, 1,000, 10,000, or 100,000 microhenries respectively.
- (3) Obtain silence in phones by adjusting C_2 (roughly, by switch); then R; then C_2 (finely, by rotary condenser). When C_2 and R are *both* finally adjusted, silence should be almost perfect. Then

$$L \text{ (microhenries)} = M \times R \text{ (ohms)}.$$
- (4) Beware of inductance of leads to terminals L; and of induction between coil under test and phones, especially when $M = 0.01$.
- (5) Exceptionally, when r is very large, it is convenient to plug r_2 to a value less than r_1 .

FIG. 3.—INDUCTANCE BRIDGE.

TABLE I.

Inductances measured by the bridge, using for R :—

- (a) Paul non-reactive decade resistance box;
 (b) "Megger" decade resistance box.

Microhenries.	
By (a).	By (b).
3.7	3.9
17.6	17.7
554	554
5,150	5,140
47,500	47,400

Simple, *i.e.*, not bifilar, bobbin resistances of 10, 100 and 1,000 ohms were also found to be satisfactory. A cheap resistance box (for R) made up with such bobbins is shown in Fig. 4. In a subsequent improvement a twelfth stud was added to each dial—a great convenience in balancing at values of R with which otherwise a change of \pm one stud would not be possible on each dial (*e.g.*, on the hundreds dial if $R = 8050$).

The first bridge set up having been constructed with independently measured * capacity and resistances, two coils were measured on the bridge and at the National Physical Laboratory. The values obtained are shown in Table II.

TABLE II.

Microhenries.	
N.P.L.	Bridge.
82.8	83.2
1,064	1,051

CAPACITY BRIDGE.

The method adopted for measuring capacities was that of a simple Wien bridge comparison between the unknown capacity and a variable known capacity, with resistance ratio arms, buzzer for generator, and telephone for detector, as in Fig. 5. Except when there is a leakage defect, wireless condensers present sensibly pure capacity in such a bridge. There is therefore a single condition for balance, and the frequency is not involved; *viz.*

$$C/C' = R/R'$$

In order to measure unknown capacities which are smaller than the minimum capacity of the calibrated condenser C' , and at the same time to correct for stray capacities which are perceptible when the unknown condenser is small (*e.g.*, a few micromicrofarads), the capacity C is made up of the unknown condenser (when connected) plus an uncalibrated fixed mica condenser and small adjustable air condenser in parallel within the instrument.

* At the Signals Experimental Establishment, without any refinements.

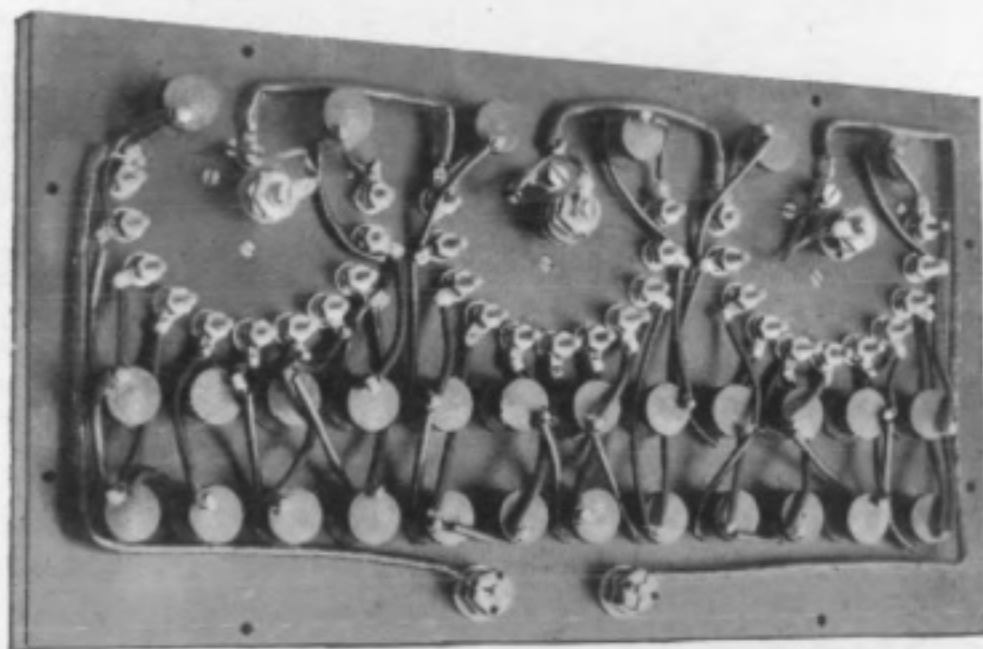
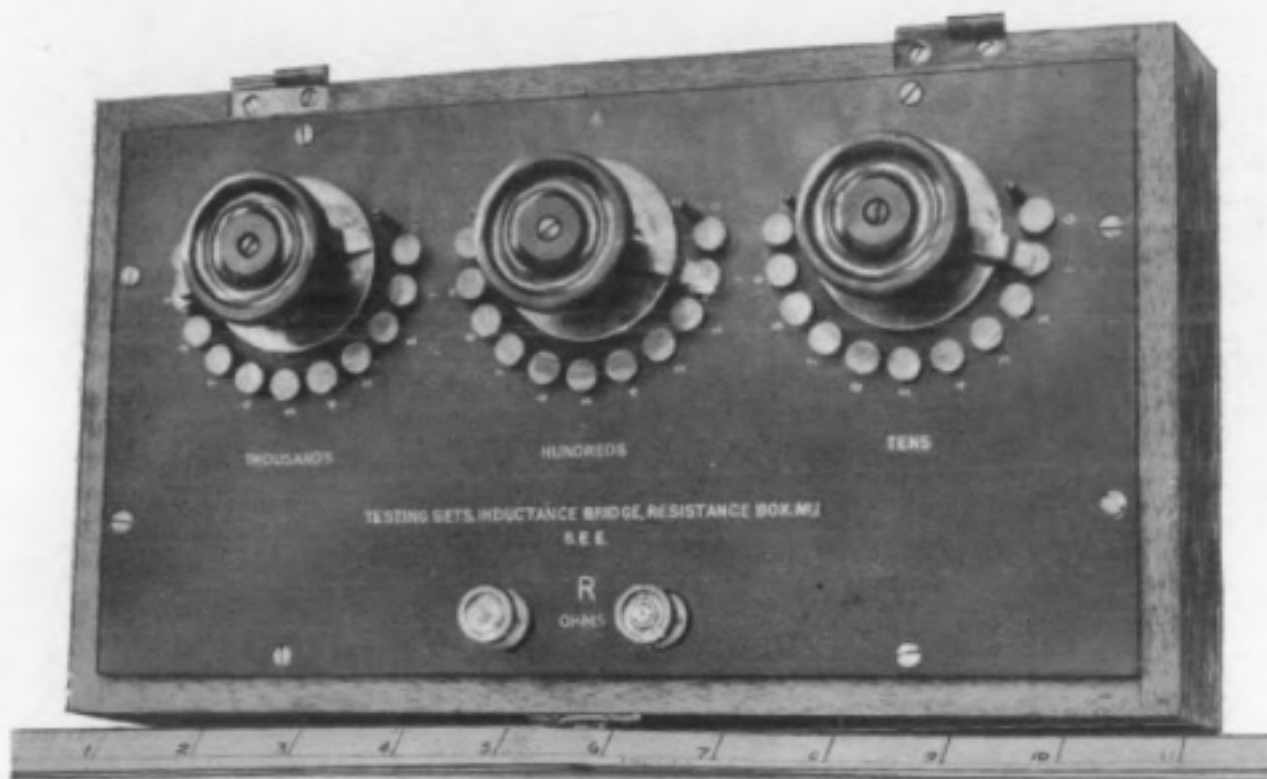

FIG. 4.—RESISTANCE BOX.

(To face page 588.)

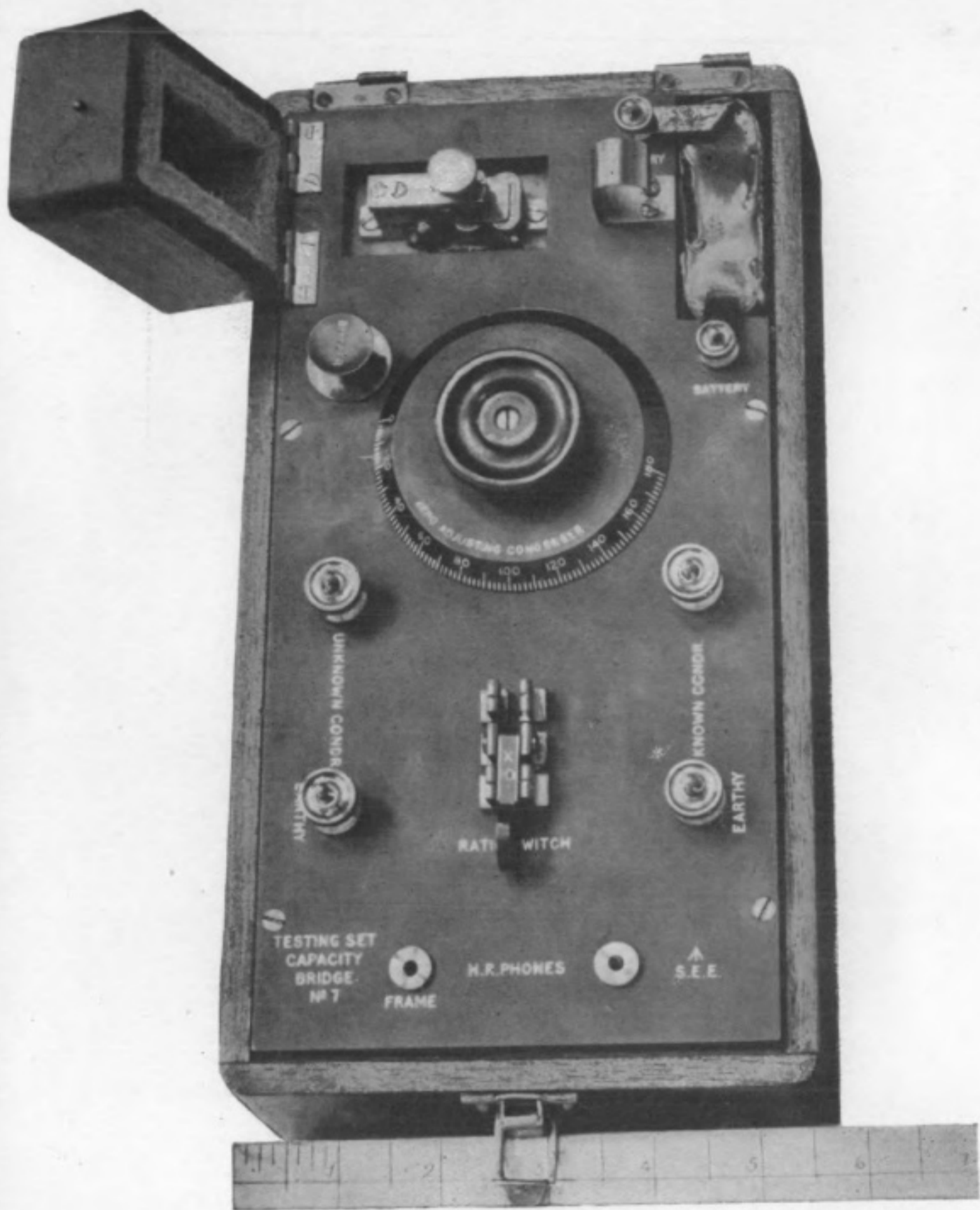

FIG. 6.—CAPACITY BRIDGE.

(To face page 589.)

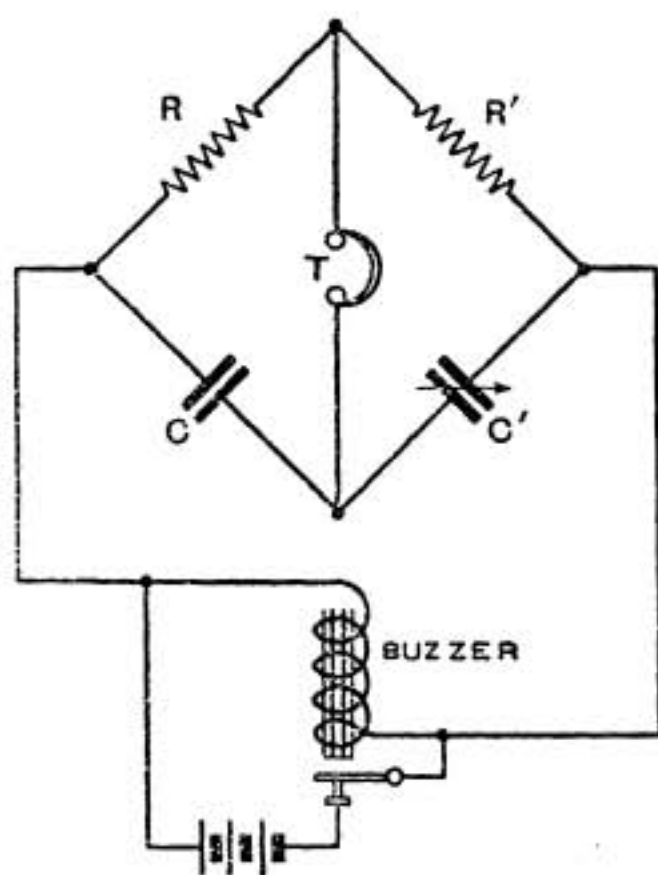

FIG. 5.—CONNECTION SCHEME OF CAPACITY BRIDGE.

The bridge is balanced before and after finally connecting the unknown condenser, which is thus measured by the difference $(C_2 - C_1)$ between the two readings of C' . The small internal adjustable air condenser, referred to as the zero adjusting condenser, is provided to save mental effort by making C_1 assume a value (such as 100 micromicrofarads) convenient for subtraction from C_2 .

A photograph of the bridge, exclusive of the external calibrated condenser C' , is reproduced in Fig. 6. The overall dimensions are approximately the same as those of the inductance bridge (Fig. 2). Fig. 7 shows the actual connections and values adopted in the instrument, together with the instructions for use. It will be seen that two resistance ratios are provided, 1 : 1 and 10 : 1.

The external adjustable calibrated condenser C' may be of any pattern

and size. The bridge was primarily designed for use with an air condenser of high quality (by H. W. Sullivan) with scale calibrated in micromicrofarads between about 70 and 1,200. Capacities between 2 and 11,000 micromicrofarads are then measurable with great ease and rapidity. A testimonial at once to the precision with which the balance can be observed, and to the constancy of good mica-wax condensers and of the Sullivan adjustable air condenser, is provided by Table III. Measurements of three mica-wax condensers were made with the bridge independently on different occasions separated by considerable intervals of time, and gave the fairly close results shown in the Table.

TABLE III.

Micromicrofarads.		Months of interval.
First measurement.	Second measurement.	
5,250	5,270	1
415	413	10
409	409	10

It may be suggested that the measurement at low frequency of condensers destined for high frequencies might lead to error or confusion. But it must be remembered that air capacities do not depend on frequency at all, and that mica capacities vary only very slightly indeed over the range of frequencies we are concerned with. H. L. Curtis * found for mica that changing

* *Electrical Review and Western Electrician*, 1911.

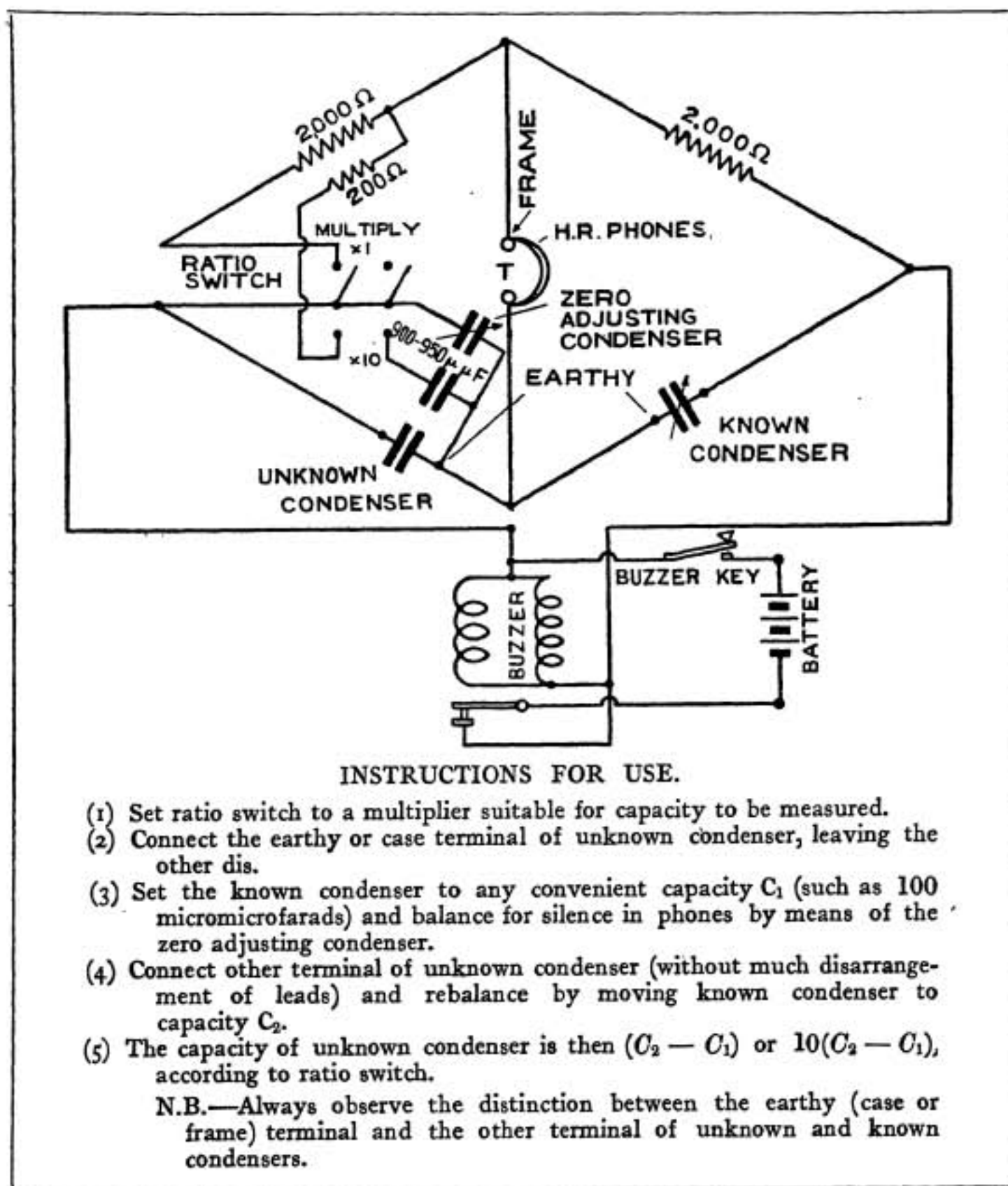

FIG. 7.—CAPACITY BRIDGE.

the frequency from 12 to 1,200 periods per second altered the capacity by only some 0.07 per cent.; and the present writer's measurements with a mica-wax condenser show that a change from buzzer frequency to 6×10^6 periods per second was accompanied by a change in capacity of certainly less than 1 per cent. It may be added that Curtis also found that changing the P.D. of a mica condenser between nearly zero and 50 volts altered the capacity by only about 0.1 per cent.

The Diffraction of the Field by a Cylinder and its Effect on Directive Reception on Board a Ship.

By Commandant RENÉ MESNY.

(Continued from page 540.)

II.—APPLICATION TO SHIPS.

9. General Formula for the Deviation of the Radiogoniometric Bearings taken on a Ship.—Let us now examine the deviation to which an observation made with a radiogoniometer on board a ship is subjected. Since the frame aerials used are of small dimensions, we may assume that the field is uniform over their area, and so we need only examine the field at their centre.

It has been shown elsewhere that a field in quadrature with the main field can be compensated, and will not produce any appreciable deviation if the ratio between the field in quadrature and the main field is less than one-twentieth.

Hence we can examine the deviation by combining the wave field H' with the inphase disturbing field Y_1 , and by calculating the angle δ between H' and their resultant. Fig. 5 shows the fields H' and Y_1 in the plane yz , taking account of the conventions of sign defined above, the x axis being parallel to the axis of the ship.

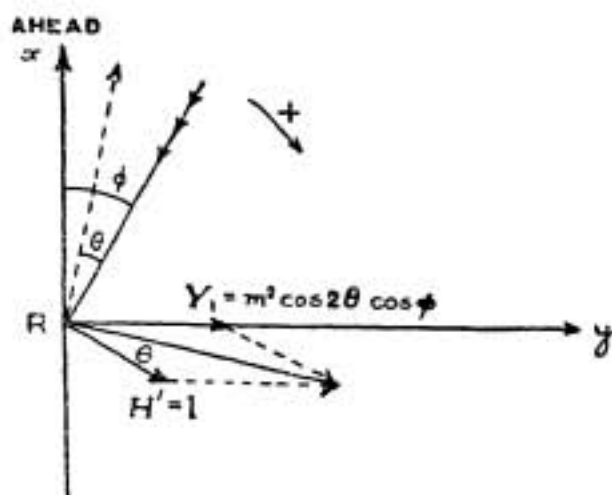

FIG. 5.

Hence for the deviation of the field H' from the resultant, *i.e.*, if $\delta =$ (observed azimuth — true azimuth), we find by projecting H' and Y_1 on the normal to their resultant

$$\sin \delta + m^2 \cos 2\theta \cdot \cos \phi \cdot \sin (\phi - \delta) = 0$$

whence
$$\tan \delta = -\frac{m^2 \cos 2\theta}{2} \times \frac{\sin 2\phi}{1 + m^2 \cos 2\theta \cos^2 \phi} \dots (16)$$

10. Radiogoniometer on the Ship's Axis.—If the apparatus is on the ship's axis $\theta = 0$, and we may write the preceding equation in the form

$$\tan \delta = - \frac{m^2}{(2 + m^2) + m^2 \cos 2\phi} \cdot \sin 2\phi \quad \dots \quad (17)$$

By examination of this formula we are led to the following conclusions:—

- (a) The deviation is independent of the wavelength.
- (b) It takes a quadrantal form, with maxima at bearings of 45° , 135° , 225° , and 315° .
- (c) The observed bearing is always nearer the axis than the true bearing.
- (d) The slope of the curve is greater athwartships than in a fore-and-aft direction.

11. Tests.—The above paragraphs (a), (b) and (c) agree well with observations; it is known that the deviation is only dependent on the wavelength when it is less than three times the length of the ship—in which case the theoretical results are evidently no longer applicable.

With a view to verifying equation (17) quantitatively Table I. below has been prepared, giving the following particulars, all lengths being in metres.

L = maximum length of the vessel.

l = maximum width of the vessel.

c = maximum depth of the vessel.

l' = width of vessel at the point where the radiogoniometer is fitted.

c' = depth of vessel at the point where the radiogoniometer is fitted.

h = height of the centre of the radiogoniometer above the upper deck.

d = distance of the radiogoniometer from the stern.

ρ_m = mean radius of the section of the ship at the place where the radiogoniometer is fitted.

Δ = the maximum observed deviation.

Δ' = the maximum deviation calculated from ρ_m and h .

ρ_0 = the radius of the imaginary cylinder which would produce the same deviation as the ship, calculated from equation (17) by means of m and Δ .

TABLE I.

Name of Vessel.	L	l	c	l'	c'	h	ρ_m	Δ'	Δ	ρ_0	d
<i>Leonce Raynaud</i>	35	6.0	3.0	6.0	3.0	2.10	2.25	7.5°	7.5°	2.25	21
Ditto . . .	35	6.0	3.0	6.0	3.5	3.60	2.40	4.5°	4.0°	2.15	4.5
<i>Dunois</i> . . .	78	8.5	6.8	8.5	6.8	5.75	3.80	4.5°	5.0°	4.15	30
Ditto . . .	78	8.5	6.8	5.1	3.4	3.50	2.10	4.0°	7.0°	3.50	—
<i>Gloire</i> . . .	140	20.2	13.5	10.0	13.5	3.50	5.90	10.7°	11.0°	6.10	11
<i>Paris</i> . . .	165	27.0	16.0	14.5	14.0	3.50	7.10	12.0°	9.0°	4.60	19
Ditto . . .	165	27.0	16.0	25.0	16.0	10.00	10.20	6.0°	8.0°	14.00	55

The agreement between Δ and Δ' on the one hand, and between ρ_m and ρ_0 on the other is as close as could be expected in the cases of the figures printed in heavy type. For the others the differences are rather large, but they nevertheless suffice to establish the principles upon which the formula is based. It may be noted also that the discordant results in the case of the *Dunois* and the first deviation readings of the *Paris* occur with the radiogoniometer very close to the stern, and that in the case of the second reading of the *Paris* the radiogoniometer was on a cabin of rather large size, of which no account has been taken. Further, in these three cases the apparatus was only 3—4 metres away from large metallic bodies (superstructure, masts, turrets).

Finally paragraph (b) is again verified by the deviations of the *Leonce Raynaud*. These deviations are set out by the points marked in Fig. 6.

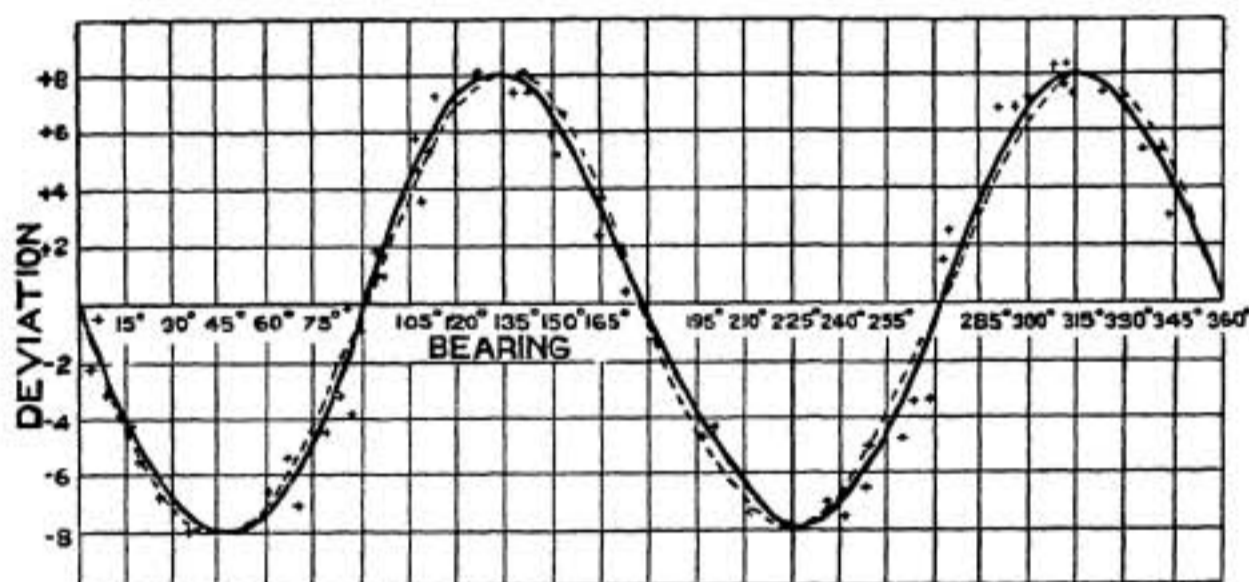

FIG. 6.—DEVIATION CURVES OF THE "LEONCE RAYNAUD."

Full line curve :— $\tan \delta = -\frac{m^2 \sin 2\phi}{2 + m^2 + m^2 \cos 2\phi}$
 Dotted curve :— $\tan \delta = 7.5^\circ \sin 2\phi$.

The full curve on this diagram is the curve given by equation (17) and the dotted curve that given by $\tan \delta = -\Delta \sin 2\phi$. It is seen that the former agrees better with the observations as a whole than does the latter.

12. Variation of the Deviation with the Height of the Radiogoniometer.—The maximum deviation is given by the formula :

$$\tan \Delta = \frac{m^2}{2 + m^2} = \frac{\rho_0^2}{2\rho^2 + \rho_0^2}$$

or if h is the height of the centre of the frame above the deck

$$\tan \Delta = \frac{\rho_0^2}{3\rho_0^2 + 4\rho_0 h + 2h^2}$$

From this it is evident that the maximum deviation which is obtained when $h = 0$ is

$$\Delta_{\max} = 18.5^\circ$$

Of course this maximum value is only valid for waves considerably longer than the vessel (approximately three times).

Table II. gives the approximate deviations that may be expected as functions of the height h of the centre of the frame above the deck and of the mean radius ρ_m of the hull of the vessel at the point where the radiogoniometer is fitted—the radius ρ_m being taken as one-fourth of the sum of the width and depth of the vessel.

TABLE II.

ρ_m Metres.	Heights h in metres.						
	1	2	3	5	10	20	30
2.5	11.5°	7.6°	5.4°	3.0°	1.1°	—	—
4.0	13.6°	10.3°	8°	5.1°	2.2°	—	—
6.0	15.0°	12.4°	10.3°	7.3°	3.7°	1.5°	—
10.0	16.3°	14.5°	12.8°	10.3°	6.3°	3.0°	1.7°

13. Radiogoniometer in other Positions.—For these cases we must apply equation (16) which only differs from the one corresponding to the case with the apparatus on the axis in that the term m^2 is multiplied by $\cos 2\theta$. Therefore if we assume that the bulwarks do not introduce any disturbances in the phenomenon studied, there should only be a diminution of the deviation.

On the other hand the quadrature field X_2Y_2 (see section 7) which disappears on the axis will no longer be zero, and the compensation will be modified. It has been shown elsewhere that the component of the quadrature field which gives rise to the compensation is the one normal to the principal field. Therefore neglecting Y_2 (which is small compared with X_2), it is obviously given by

$$X_2 \cos \phi = \frac{\pi \rho_0}{\lambda} \left(\frac{\rho_0}{\rho} \right) \sin \theta \cdot \sin^2 \phi \cdot \cos \phi.$$

The curve of this function is again of the quadrantal form, but it is much flatter for $\phi = 0^\circ$ or 180° than for $\phi = 90^\circ$ or 270° . For the two former values of ϕ it is even tangent to the axis of the bearings of the transmitter.

No results are available of observations taken on such installations, but the curves in Fig. 9, which will be dealt with in section 15, provide a confirmation of the preceding facts.

14. The Effective Height of a Ship Antenna.—In section 8 it was shown that the vertical electric field of the ship was equal to $(\rho_0/\rho)^2$

when the wave field was 1. It therefore adds to this latter and gives the same resultant as would an increase of the effective height. Thus the hull participates with the aerial in the work of reception whatever the direction of the incoming wave. Let us examine the magnitude of this effect.

Let A B, Fig. 7, represent the downloads of an antenna, of which we may suppose the whole of the capacity to be concentrated in a horizontal part situated at B. Its effective height, taking account of the wave field only, will be equal to A B, but to this field, assumed equal to unity, must be

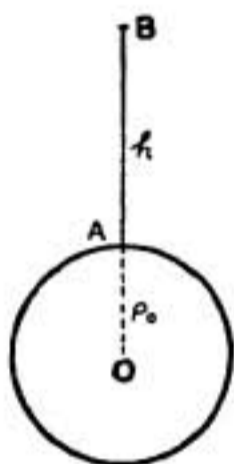

FIG. 7.

added at each point, the field due to the ship, which equals $(\rho_0/\rho)^2$. This is the same as if we added its mean value throughout the whole height of the antenna. This mean value, putting A B = h , is

$$\frac{1}{h} \int_{\rho_0}^{\rho_0+h} \left(\frac{\rho_0}{\rho}\right)^2 dh = \frac{\rho_0}{\rho_0+h}$$

The mean field acting on the aerial is therefore

$$1 + \frac{\rho_0}{\rho_0+h}$$

or in another form, the effective height of the antenna is multiplied by the factor $\left(1 + \frac{\rho_0}{\rho_0+h}\right)$.

This increase is far from being negligible particularly for torpedo boats or submarines with very low aerials.

We may therefore state the following proposition:—

To obtain the effective height of a ship's aerial for reception, the height h above the upper deck calculated by the usual methods, must be multiplied by the factor

$$1 + \frac{\rho_0}{\rho_0+h}$$

where ρ_0 is one-fourth of the sum of the width and the depth of the vessel.

III.—APPLICATIONS TO DIRECTION FINDERS ON HILLS.

15. Analogies with the "Cylinder" Problem.—Some results obtained with Direction Finding stations installed on hills have already been published. The most interesting are those relative to the Ile des Sanguinaires in Corsica. The map of this island which lies in a N.E.—S.W. direction is given in Fig. 8. It has an almost rectilinear summit at an altitude varying slightly around 75 metres.

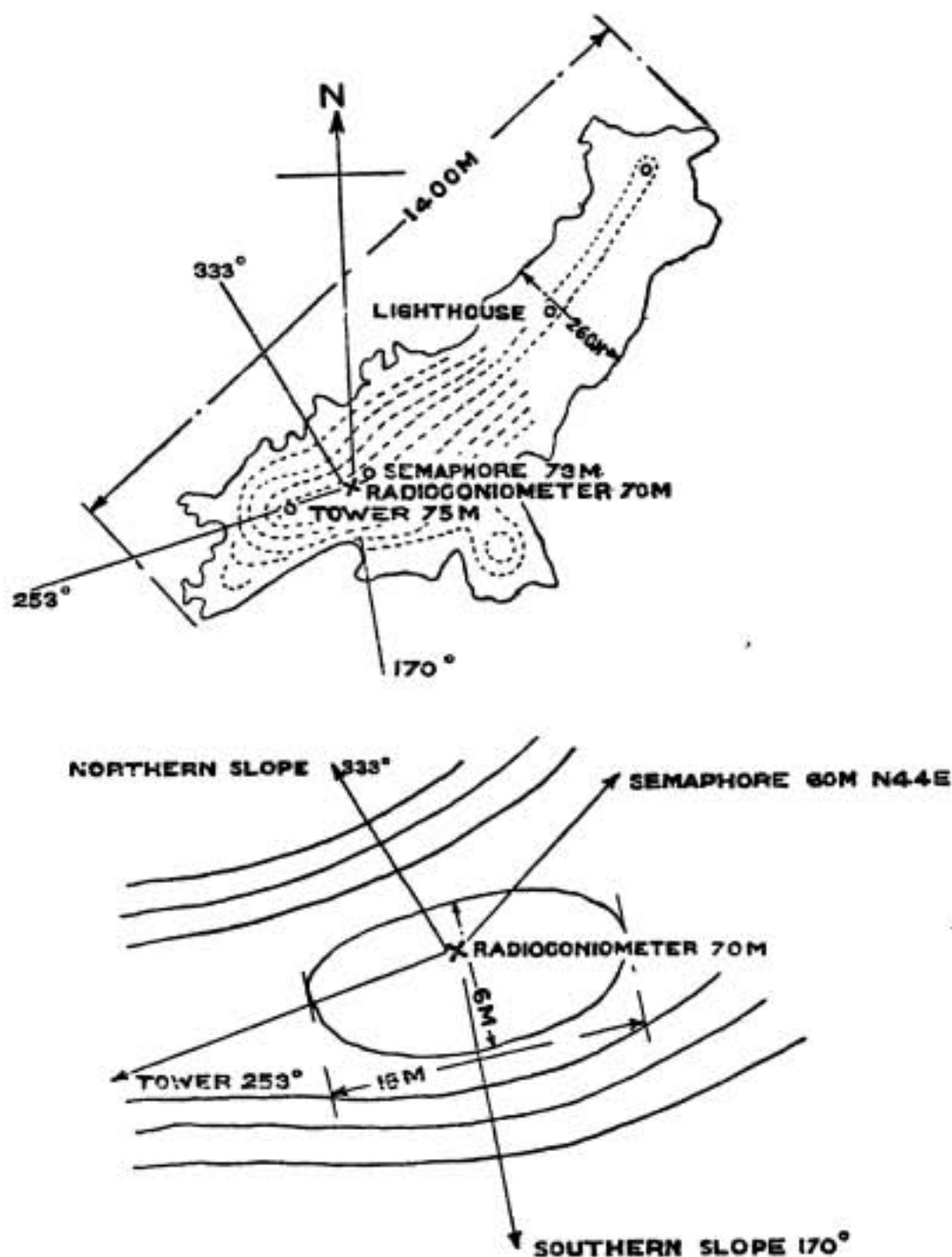

FIG. 8.—MAP OF THE ILE DES SANGUINAIRES (CORSIKA).
The lower diagram shows the location of the radiogoniometer.

The comparison of this case with that of a semi-cylinder is obviously impossible, and the problem of this form of obstacle must be treated separately. Nevertheless it is felt that certain analogies exist between the two questions, and this feeling is fully confirmed by an examination of the curves in Fig. 9.

(a) The deviation is quadrantal.

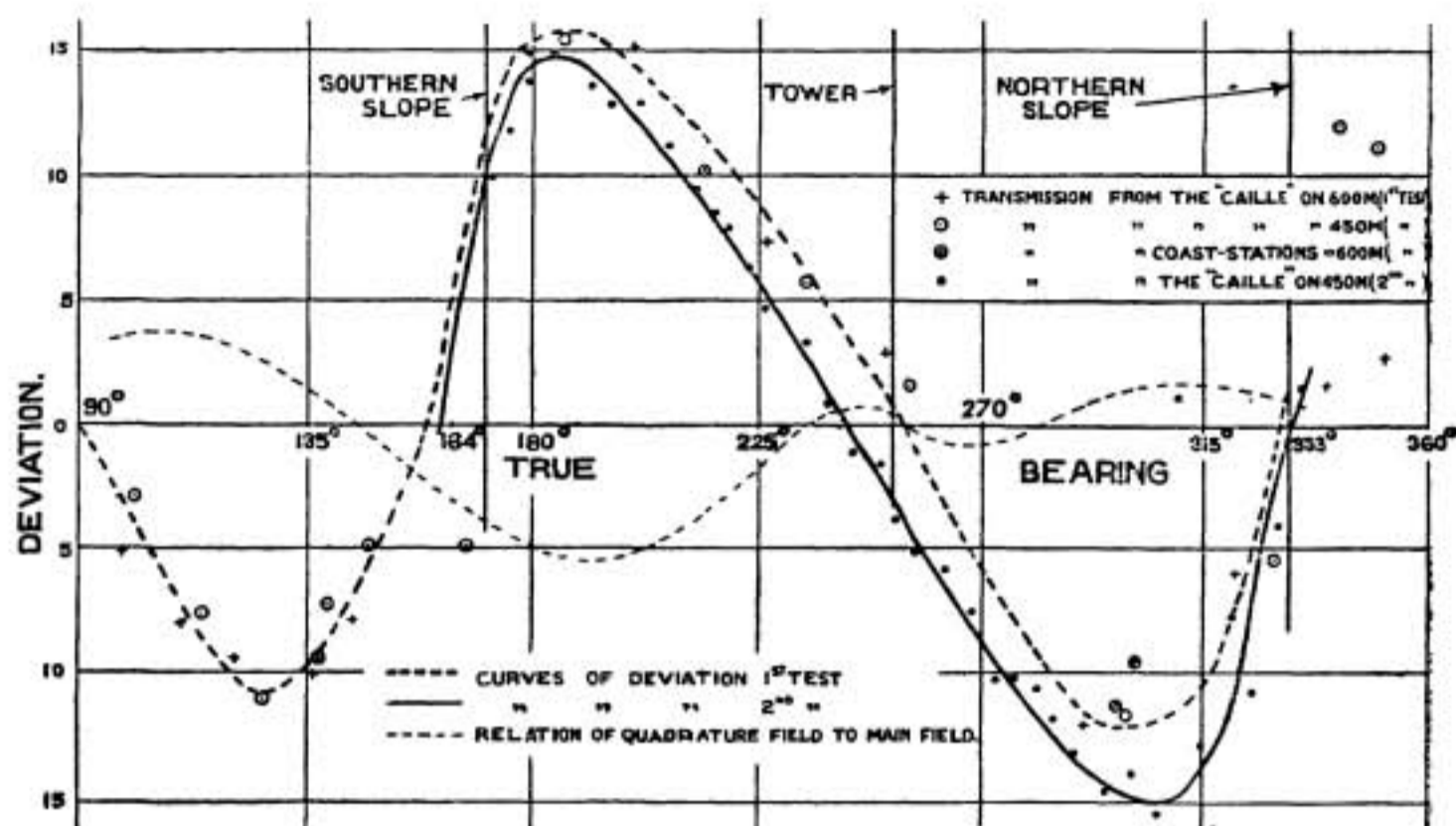

FIG. 9.—DEVIATION CURVES FOR THE ILE DES SANGUINAIRES.

- (b) It is zero along the axis, and across the island.
 (c) The slope of the curve is steeper at the zero corresponding to bearings across the island, than for those in the neighbourhood of the axis.
 (d) And finally the curve of the disturbing field in quadrature with the main field confirms the prediction of section 13. It is quadrantal and becomes tangential to the axis of the true bearings in the direction of the axis of island.

16. Variation of the Field in the Neighbourhood of the Summit.—The second sketch in Fig. 8 gives details of the mounting of the direction finder on the crest of the island. It is installed on a small elliptic plateau which had been prepared during the war for the mounting of a battery; it was not placed exactly at the centre of this small plateau, but as the latter was entirely on the crest, the radiogoniometer may be regarded as being very close to the vertical plane passing through the mean summit line.

If in the absence of a better analysis we seek to extend the conclusions of the preceding investigation to this actual case, we might suppose θ to be very small and the disturbing field in quadrature to be negligible. This is, however, far from being the case.

Among the hypotheses to which this statement might give rise the following seems the most plausible:

On the summit of a hill with steep sides, the field at a point varies rapidly as the point moves over relatively short distances (a few metres only). It will thus be possible in a restricted space to find sites possessing very different properties for the installation of the Direction Finding station.

SPECIAL EDITORIAL NOTICE.

In view of the greater convenience for indexing and reference purposes of technical periodicals which have their volumes running concurrently with the year, it has been decided to extend the present volume of the "Radio Review" to December next. Volume II. will therefore commence with the January, 1921, issue. The publication of the classified index to the Abstracts in the current volume will therefore be held over to the early part of next year.

The Power required for Long Distance Transmission.

By THE EDITOR.

In referring to the wavelength at which a transmitting aerial is working it is customary to take as a basis of reference the wavelength corresponding to the fundamental frequency of the aerial, *i.e.*, with all tuning coils cut out. As we showed in our last issue, however, there is another characteristic wavelength, namely that at which the total effective resistance is a minimum. At this wavelength the dielectric losses are twice as great as the radiated power. In this article we propose to show the importance of this wavelength in all calculations of the efficiency of radio transmission.

Assuming the aerial to have a large upper capacity and to be radiating at a wavelength very large compared with the height, we have for the radiated power

$$P_{rad} = 1.584 \frac{h^2}{\lambda^2} I^2 \text{ kilowatts}$$

where I is the root-mean-square current in amperes. The electric field strength at a distant point of the earth's surface is given by the formula

$$\begin{aligned} E &= \frac{4\pi}{10} \cdot \frac{h}{\lambda} \cdot \frac{I}{d} \text{ e.s. units} \\ &= 120\pi \frac{h}{\lambda} \cdot \frac{I}{d} \text{ volts per cm.} \end{aligned}$$

where d is the distance in centimetres. This is the theoretical value on the assumption that the earth is a plane perfect conductor and that the atmosphere is a perfect dielectric of infinite extent.

Now the power supplied to any receiving station by the electromagnetic waves is proportional to E^2 , and to be able to read the signals through atmospheric disturbances it is necessary that the value of E at the receiving station should exceed a certain value. This is not much affected by the size of aerial and degree of amplification employed since these factors influence the loudness of both signals and atmospheric noises. We are neglecting here any secondary differences due to directive effects, etc.

Putting D for the distance in kilometres, we have

$$E^2 = \frac{14400 \cdot \pi^2}{10^{10}} \cdot \frac{h^2}{\lambda^2} \cdot \frac{I^2}{D^2} \quad (E = \text{volts per cm.})$$

and therefore

$$\begin{aligned} \frac{P_{rad}}{E^2} &= \frac{1.584 \cdot 10^{10}}{14400 \cdot \pi^2} \cdot D^2 \left(\frac{\text{kilowatts}}{(\text{volts per cm.})^2} \right) \\ &= 1.11 \cdot 10^5 \cdot D^2 \end{aligned}$$

If P is the total power supplied to the transmitting aerial, the ratio of P_{rad} to P may be called the efficiency of the aerial and we may write

$$\frac{P_{rad}}{P} = \eta.$$

We shall assume here that the theoretical formula just established is brought into agreement with experimental results by the introduction of the Austin-Cohen exponential factor. The formula then becomes

$$\frac{P}{E^2} = 1.11 \cdot 10^5 \cdot \frac{D^2}{\eta} \cdot \epsilon^{0.003D/\sqrt{\lambda}}$$

where D and λ are both in kilometres.

L. W. Austin found that to give readable signals at Brant Rock when receiving from U.S. cruisers, it was necessary to have a received current of 40 microamperes set up in the antenna which had a total effective resistance of 25 ohms and an effective height of about 200 feet. To produce a current of $40 \cdot 10^{-6}$ amperes in 25 ohms requires an electromotive force of 0.001 volt, which divided by the effective height of the aerial gives a field strength of $1.64 \cdot 10^{-7}$ volts per centimetre.

Inserting this value of E in the above formula we get

$$P = 3 \cdot 10^{-9} \cdot \frac{D^2}{\eta} \cdot \epsilon^{0.003D/\sqrt{\lambda}} \text{ kilowatts.}$$

To ensure a reliable commercial service under all conditions a considerable factor of safety should be introduced. Assuming a factor of 5, the formula becomes

$$P = 15 \cdot 10^{-9} \cdot \frac{D^2}{\eta} \cdot \epsilon^{0.003D/\sqrt{\lambda}} \text{ kilowatts.}$$

This gives an electric field strength E at the receiving station of 0.37 micro-volt per cm.

We shall now consider more closely the value of the efficiency η of the transmitting aerial. Let β be the ratio of the conductor resistance R_w of the aerial-earth system, which we assume to be constant for all wavelengths, to the minimum value R_m of the total effective resistance; then

$$R_w = \beta R_m = \beta(R_{dm} + R_{rm})$$

where R_{dm} and R_{rm} are the dielectric and radiation resistances, respectively, at the wavelength λ_m for which the total effective resistance R_m is a minimum.

Since, at this wavelength, $R_{dm} = 2R_{rm}$, we have

$$R_m = \beta R_m + 3R_{rm}$$

and

$$R_{rm} = R_m \cdot \frac{1 - \beta}{3}.$$

Since the dielectric resistance is directly proportional to λ , whilst the radiation resistance is inversely proportional to λ^2 , we have

$$\begin{aligned} R &= \beta R_m + 2\gamma R_{rm} + \frac{R_{rm}}{\gamma^2} \\ &= R_m \left\{ \beta + \frac{1 - \beta}{3} \left(2\gamma + \frac{1}{\gamma^2} \right) \right\} \end{aligned}$$

where

$$\frac{\lambda}{\lambda_m} = \gamma.$$

Of this total resistance R , the only useful part is that representing the radiation, viz. :—

$$R_r = \frac{R_{rm}}{\gamma^2} = R_m \frac{1 - \beta}{3\gamma^2}.$$

Hence

$$\frac{1}{\eta} = \frac{R}{R_r} = \frac{3\gamma^2\beta}{1 - \beta} + 2\gamma^3 + 1$$

Table I. below gives the calculated values of $1/\eta$ for various values of β and γ . These values are plotted in Fig. 1 for $\beta = 0.1, 0.3, \text{ and } 0.5$.

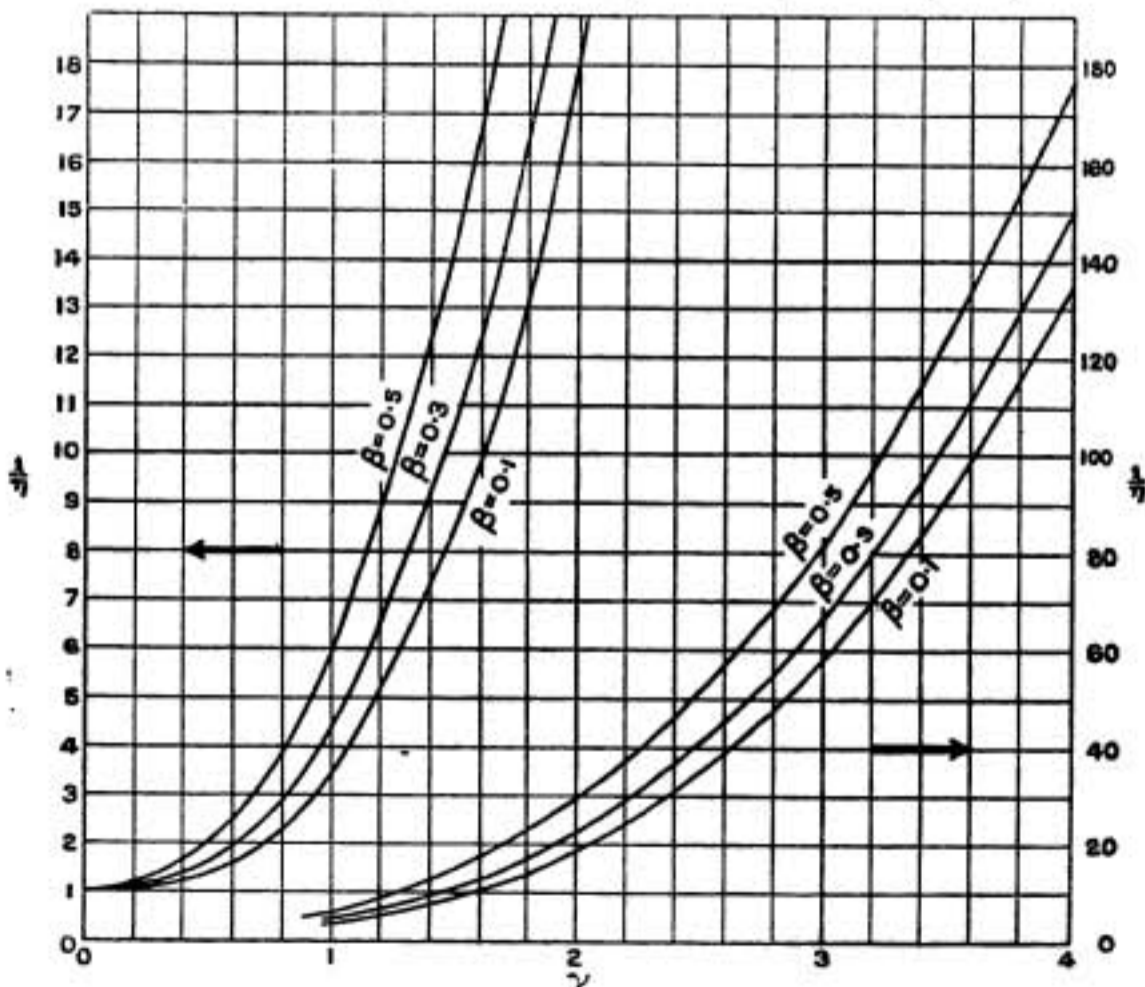

FIG. 1.

TABLE I.

$$\frac{1}{\text{aerial efficiency}} = \frac{1}{\eta}$$

$\beta = \frac{E_w}{E_m}$	$\gamma = \lambda/\lambda_m =$								
	0.5	0.75	1	1.5	2	2.5	3	4	5
0.1	1.33	2.03	3.33	8.5	18	34	58	134	259
0.2	1.44	2.26	3.75	9.4	20	37	62	141	270
0.3	1.57	2.56	4.3	10.6	22	40	67	150	283
0.4	1.75	2.96	5	12.2	25	45	73	161	301
0.5	2.0	3.53	6	14.5	29	51	82	177	326

TABLE II.

Power in kilowatts for $D = 1,000$ kilometres.

λ_m	β	$\gamma = 0.5$	$\gamma = 0.75$	$\gamma = 1$	$\gamma = 2$	$\gamma = 3$	$\gamma = 5$
0.5	0.1	8.05	4.1	3.5	5.5	10.1	26
	0.5	12.10	7.1	6.3	8.7	14.25	32.75
1.0	0.1	1.4	1.0	1.0	2.3	4.9	14.85
	0.5	2.1	1.7	1.8	3.6	6.95	18.7
2.5	0.1	0.3	0.275	0.335	1.05	2.6	9.1
	0.5	0.45	0.475	0.6	1.65	3.7	11.4
5.0	0.1	0.135	0.145	0.2	0.7	1.9	7.05
	0.5	0.2	0.25	0.35	1.1	2.65	8.9
10.0	0.1	0.075	0.09	0.13	0.535	1.5	5.95
	0.5	0.115	0.16	0.235	0.845	2.125	7.5

These figures are very striking; they show that if a warship with an aerial for which $\lambda_m = 1,000$ metres transmits at a wavelength of 3,000 metres, less than 2 per cent. of the energy actually supplied to the aerial is radiated, the remaining 98 per cent. being dissipated in aerial losses, whereas at a wavelength of 1,000 metres 30 per cent. may be radiated.

If the values of β and γ are known the corresponding value of η can be substituted in the formula established above for the power P which must be supplied to the transmitting aerial. It is seen that P depends only on β , γ , D , and λ_m . We have calculated P for five values of D , viz., 1,000, 2,000, 3,000, 5,000 and 10,000 kilometres, for two values of β , viz., 0.1 and 0.5, for six values of γ , viz., 0.5, 0.75, 1.0, 2.0, 3.0 and 5.0, and for five values of λ_m , viz., 0.5, 1.0, 2.5, 5.0 and 10.0 kilometres. The actual wavelength in any case is equal to $\gamma\lambda_m$.

The values of the power P in kilowatts are given in the Tables II. to VI., and in Figs. 2 to 6. The curves have only been plotted for one value of β , viz. $\beta = 0.1$.

TABLE III.

Power in kilowatts for $D = 2,000$ kilometres.

λ_m	β	$\gamma = 0.5$	$\gamma = 0.75$	$\gamma = 1$	$\gamma = 2$	$\gamma = 3$	$\gamma = 5$
0.5	0.1	13,000	2,200	980	445	475	695
	0.5	19,500	3,800	1,765	700	660	875
1.0	0.1	395	125	80	75	110	225
	0.5	590	215	145	120	155	285
2.5	0.1	17	10	9	16	31	84.5
	0.5	25.5	17	16	25.5	44	106.5
5.0	0.1	3.6	2.7	2.9	7.35	16.4	51.5
	0.5	5.35	4.2	5.25	11.65	23.15	65
10.0	0.1	1.15	1.1	1.35	4.2	10.4	36.25
	0.5	1.75	1.9	2.4	6.65	14.75	45.75

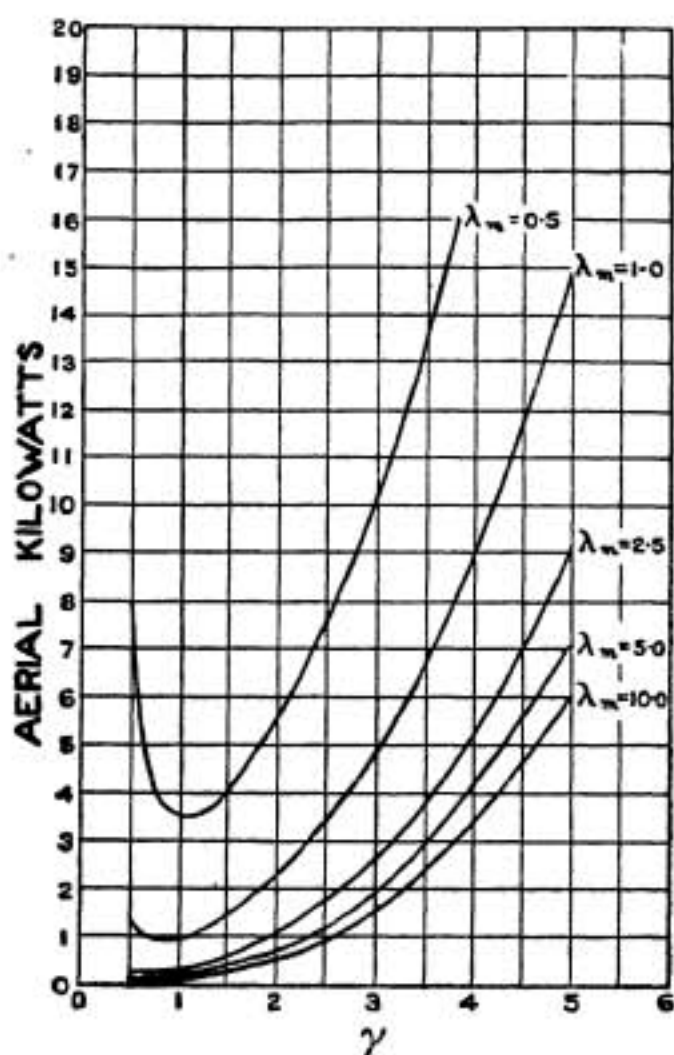

FIG. 2.

$D = 1,000$ kilometres; $\beta = 0.1$.

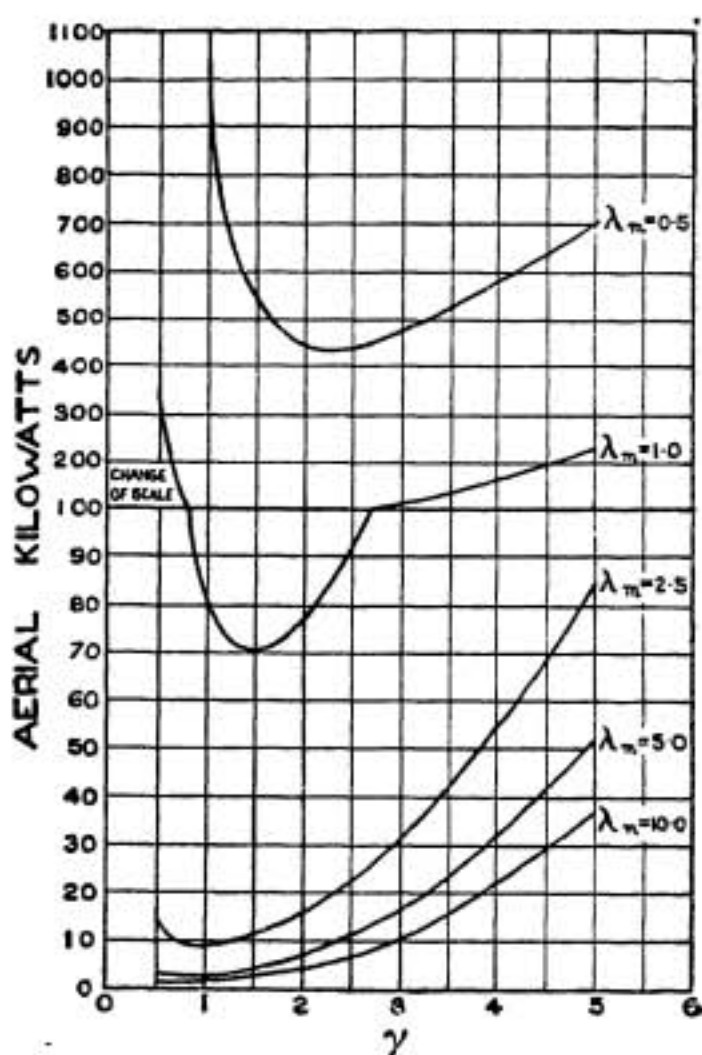

FIG. 3.

$D = 2,000$ kilometres; $\beta = 0.1$.

TABLE IV.

Power in kilowatts for $D = 3,000$ kilometres.

λ_m	β	$\gamma = 0.5$	$\gamma = 0.75$	$\gamma = 1$	$\gamma = 2$	$\gamma = 3$	$\gamma = 5$
0.5	0.1	—	—	155,000	20,000	12,200	10,450
	0.5	—	—	280,000	31,750	17,200	13,150
1.0	0.1	62,000	8,825	3,650	1,430	1,410	1,950
	0.5	93,000	15,300	6,575	2,260	1,990	2,450
2.5	0.1	560	195	135	140	210	445
	0.5	840	340	240	220	295	560
5.0	0.1	54	28.5	25	42.5	72.5	211.5
	0.5	81	50	45	67.5	102.5	265.5
10.0	0.1	10	7.5	8	18.5	40.5	125
	0.5	15	12.5	14	29	57.5	160

TABLE V.
Power in kilowatts for $D = 5,000$ kilometres.

λ_m	β	$\gamma = 0.5$	$\gamma = 0.75$	$\gamma = 1$	$\gamma = 2$	$\gamma = 3$	$\gamma = 5$
1.0	0.1	—	—	—	275,000	125,000	78,500
	0.5	—	—	—	435,000	177,000	99,000
2.5	0.1	330,000	43,500	16,600	5,600	5,200	6,800
	0.5	495,000	75,500	30,000	8,800	7,350	8,550
5.0	0.1	6,650	1,770	1,010	790	1,050	1,950
	0.5	10,000	3,085	1,820	1,250	1,485	2,450
10.0	0.1	405	180	145	195	335	805
	0.5	610	315	260	310	475	1,010

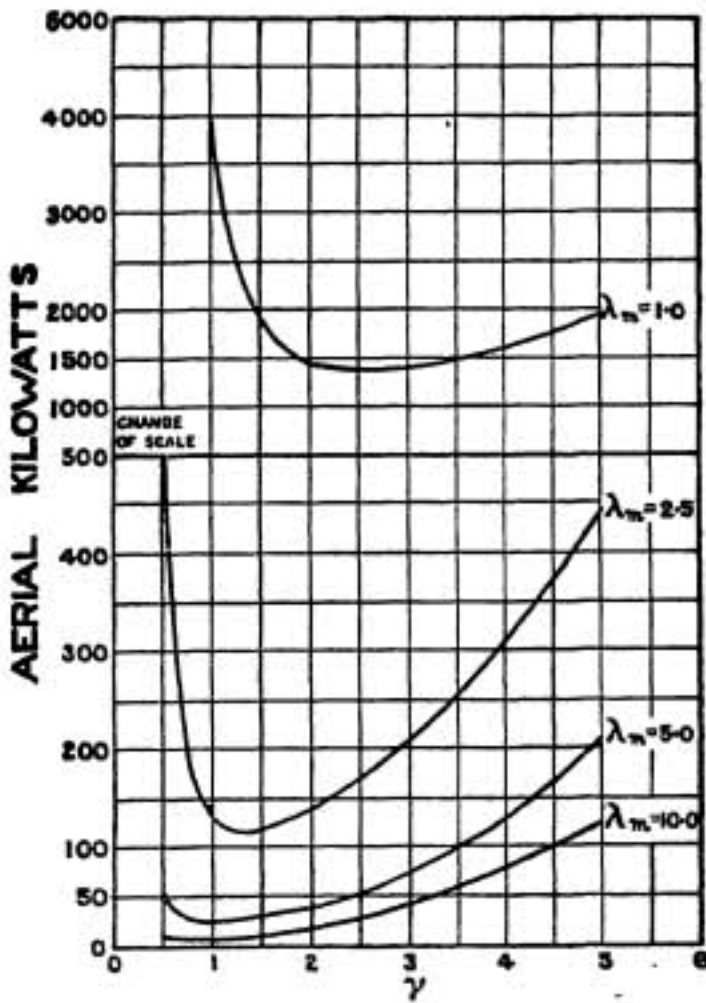

FIG. 4.
 $D = 3,000$ kilometres; $\beta = 0.1$.

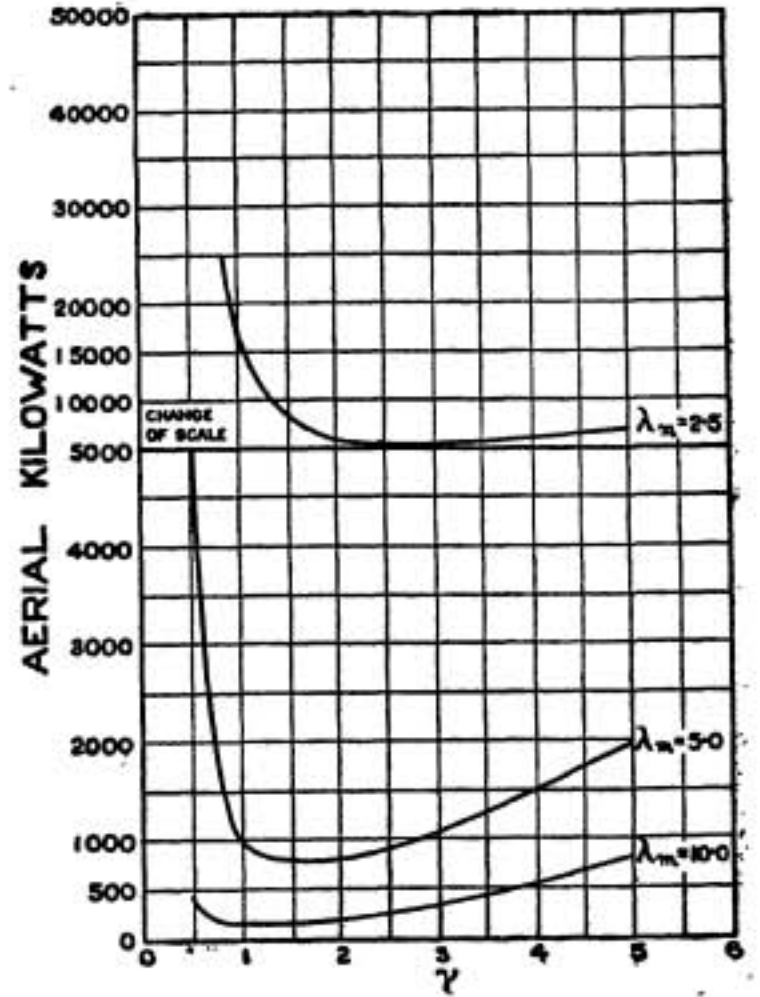

FIG. 5.
 $D = 5,000$ kilometres; $\beta = 0.1$.

TABLE VI.
Power in kilowatts for $D = 10,000$ kilometres.

λ_m	β	$\gamma = 1$	$\gamma = 2$	$\gamma = 3$	$\gamma = 5$
2.5	0.1	—	—	—	1,915,000
	0.5	—	—	—	2,410,000
5.0	0.1	—	365,000	202,500	156,500
	0.5	—	580,000	286,000	210,000
10.0	0.1	66,500	22,350	20,750	27,250
	0.5	120,000	35,300	29,400	34,300

It must be remembered that these figures are based upon the Austin-Cohen exponential factor, which is of uncertain application for distances greater than about 5,000 kilometres, and for wavelengths exceeding about 10 kilometres. We shall return to this aspect of the subject in our next number. Of less importance are the assumptions as to the constancy of the conductor resistance, and of the power-factor of the dielectric losses of the aerial.

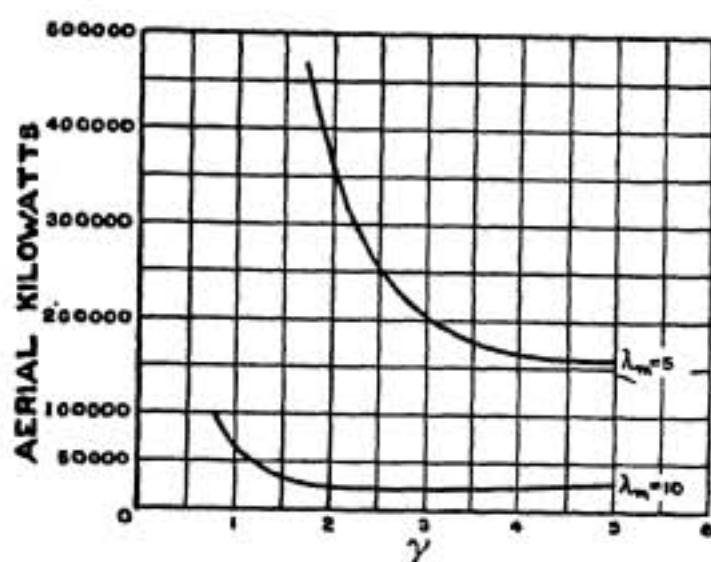

FIG. 6.
 $D = 10,000$ kilometres; $\beta = 0.1$.

The tables and curves bring out clearly the enormous saving of power which can be obtained by using aerials with high values of λ_m , that is with such small dielectric losses that the minimum total effective resistance is reached at long wavelengths.

Many of the very high values of P given in the tables are quite impracticable, since they could only be attained at impossibly high aerial voltages. They are given, however, to show the relation of the power actually employed to that which would be necessary to give signals of the assumed strength.

For a given aerial and therefore a given value of λ_m , there is always a wavelength $\lambda = \gamma\lambda_m$ at which the power necessary for a given distance is a minimum. At longer wavelengths the inefficiency of the aerial more than counteracts the improved transmission. Table VII. shows the power P in kilowatts for various distances with aerials of different values of λ_m on the assumption that the wavelength is always chosen to require the minimum value of P , and that $\beta = 0.1$. The wavelength is also given in each case.

TABLE VII.

The optimum wavelength in kilometres and the minimum power in kilowatts required to give 0.37 microvolts per cm. assuming the Austin-Cohen exponential factor.

D kms.	$\lambda_m = 0.5$		$\lambda_m = 1$		$\lambda_m = 2.5$		$\lambda_m = 5$		$\lambda_m = 10$	
	λ	P	λ	P	λ	P	λ	P	λ	P
1,000	0.5	3.5	0.9	0.9	1.75	0.27	2.5	0.134	5.0	0.076
2,000	1.15	430	1.5	70	2.4	9.0	4.0	2.7	7.5	1.1
3,000	2.5	10,500	2.5	1,400	3.5	117	5.0	25	8.5	7.3
5,000	—	—	6.0	75,000	7.0	5,100	8.75	770	12.5	150
10,000	—	—	—	—	—	—	25	157,000	30	20,000

These results are shown in Fig. 7 where the ordinates represent the logarithm of the power P in kilowatts. The actual values of P are indicated in the right-hand side of the figure. In Fig. 8 $\log_{10} P$ is plotted against $\log_{10} D$. If the power varied with the distance according to the law $P = mD^n$, we should have $\log P = \log m + n \log D$ and the curves of Fig. 8 would be straight lines. The slope of the curves gives the value of the index n , which is not a constant; its value at several points is indicated in Fig. 8.

The limiting factor in the amount of power which can be supplied to a given aerial is the voltage of the aerial at which, even if the insulators do not fail, the losses due to discharge from the wires increase very rapidly. This limiting voltage will depend on the size of wire employed and on the design of the insulators, etc., but for large well constructed aerials will probably be in the neighbourhood of 100,000 volts.

Since $I = 2\pi fVC$ where C is in farads
 I in amperes
and V in volts

we have

$$V = 0.53 \frac{I\lambda}{C'} = \frac{I\lambda}{2C'} \text{ kilovolts approximately.}$$

where C' is in milli-microfarads
and λ in kilometres.

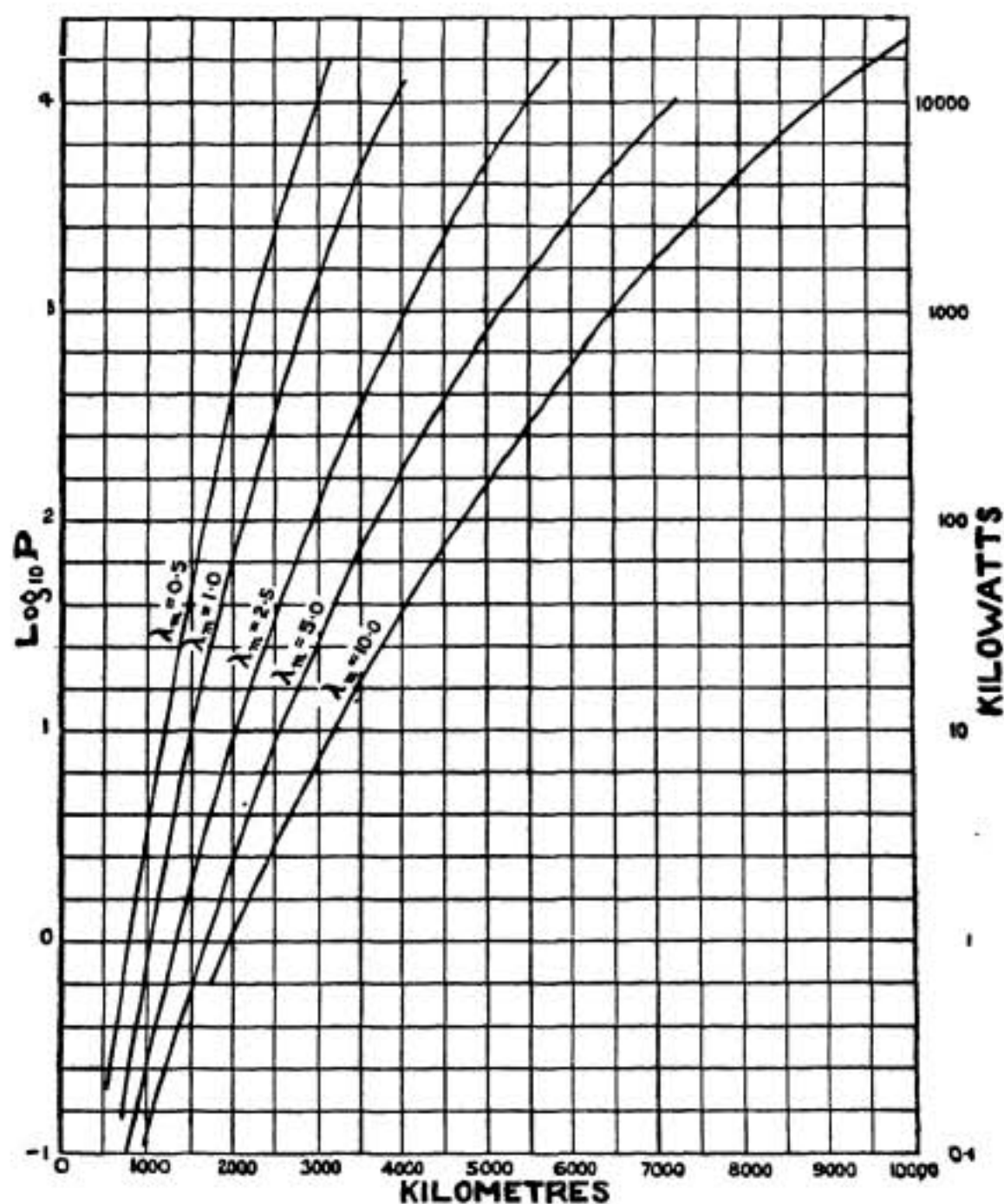

FIG. 7.

P is the power supplied to the aerial assuming the wavelength to have its optimum value in every case.

For example, if $C' = 12$ milli-microfarads

$$\lambda = 11 \text{ kilometres}$$

and $I = 200$ amperes

$$V = 0.53 \frac{200 \times 11}{12} = 97 \text{ kilovolts.}$$

Since the power P in kilowatts is equal to $I^2 R / 1,000$, where R is the total effective resistance at the working wavelength, $I = \sqrt{\frac{1,000 P}{R}}$ and

$$V = 17 \frac{\lambda}{C'} \sqrt{\frac{P}{R}} \text{ kilovolts.}$$

It is therefore a simple matter to see whether any power P can be supplied.

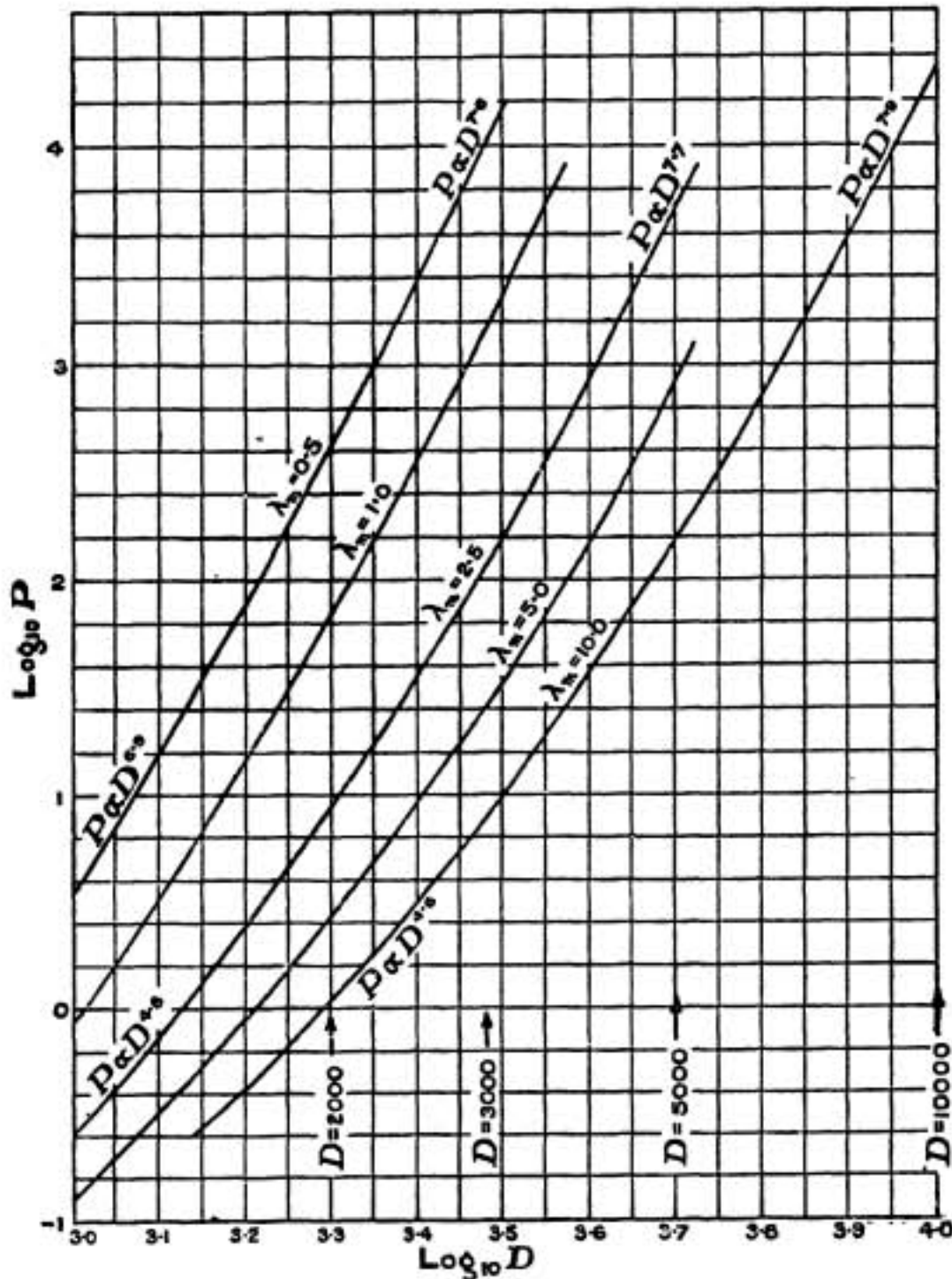

FIG. 8.

at a given wavelength to an aerial of known capacity and resistance without exceeding the permissible voltage. Conversely, from the formula

$$P = \frac{C'^2 V^2 R}{280 \lambda^2} \text{ kilowatts}$$

one can calculate the power corresponding to a given value of V . For example, if $C' = 12$ milli-microfarads, $V = 100$ kilovolts, $R = 3.75$ ohms and $\lambda = 11$ kilometres (these values apply approximately to the San Paolo, Rome, aerial) we have as the maximum power

$$P = \frac{144 \times 10^4 \times 3.75}{280 \times 121} = 160 \text{ kilowatts.}$$

Hence in some cases it may be inadvisable to work at the optimum wavelength given in Table VII. and one may be compelled to use a shorter wavelength and consequently more power than that given in Table VII. in order to keep the aerial voltage within the prescribed limits.

Review of Radio Literature.

1. Articles and Patents.

748. ON THE ELECTRICAL CHARACTERISTICS OF LOW ANTENNÆ. R. Jaeger. (*Fahrbuch Zeitschrift für drahtlose Telegraphie*, 15, pp. 318—321, April, 1920.)

The electrical characteristics of high antennæ are on the whole fairly constant and not affected to any great extent by the condition of the weather. This is not the case with cable antennæ lying on the ground and thus measurements of the usual characteristics, *e.g.*, natural wavelength, decrement and capacity, must be made for different ground conditions. This has been done for a variety of earth antennæ and also for certain types of low aerials. The natural wavelength was measured by joining the two ends of the cable through a coil possessing a small inductance and exciting the completed circuit with a Telefunken buzzer wavemeter. Resonance was detected by a loosely coupled aperiodic detector circuit. The decrement was determined by an oscillating valve method due to Brandes. The main result of the measurements is to show that an enormous increase in decrement is experienced during and shortly after rain. The natural wavelength and capacity are also altered in such cases. The decrement of a polished copper earth antenna on dry ground was greater than that of a corresponding insulated cable antenna but was smaller when laid on brushwood-covered earth.

A summary of the main results is given in the accompanying table :—

Type of Antenna.	Natural Wave-length.	Decrement.	Wave-length (metres)	Capacity (in cms.).	Weather.
Two-legged Cable Antenna .	255	0.133	700	500—600	Dry.
	255	0.329	300	500—600	Dry.
	255	0.245	700	500—600	Wet.
	255	0.640	300	500—600	Very wet.
T-Cable Antenna	300	0.150	700	600	Dry.
	300	0.366	300	600	Dry.
Low Antenna (Height 2 m.) .	—	0.077	700	—	Dry.
	—	0.150	300	—	Dry.
Two - legged Bare Copper Antenna.	—	0.215	700	345	On dry ground.
	—	0.141	547	225	On brushwood.

749. THEORY OF ANTENNA RESISTANCE. W. H. Eccles. (*Electrician*, 84, p. 370, April 2nd, 1920. *Technical Review*, 6, p. 467, May 25th, 1920—Abstract. *Science Abstracts*, 23B, pp. 277—278, Abstract No. 547, May 31st, 1920—Abstract.)

The author quotes Heaviside's theory dealing with the manner in which the Faraday lines

attached to the electric charges move up and down the antenna so that a fraction of the moving lines is detached at each oscillation.

The total current I in the antenna is assumed to be divided into two portions i and j , the former being devoted to heating the conductors of the aerial and the latter being concerned with the radiation. The ratio j/I may be taken to vary approximately as the first power of the oscillation frequency f , that is $j/I = af$, from which it is shown that the total power expended in the aerial circuit may be written as

$$P = ri^2 + mj^2 \\ = \{r - 2raf + (r + m) a^2 f^2\} I^2$$

The quantity within the brackets therefore represents the antenna resistance, and this is shown to have a minimum value of $rm/(r + m)$ when $af = r/(r + m)$.

The values given by this equation have been found to agree fairly well with measurements made on aerials, and with the variation of the antenna resistance with the wavelength.

750. ALTERNATING CURRENT WORK WITH REFERENCE TO THE THREE-ELECTRODE VALVE. R. C. Clinker. (*Wireless World*, 8, pp. 30—32, April 3rd, 1920; pp. 67—68, April 17th, 1920; pp. 102—104, May 1st, 1920. *Technical Review*, 6, p. 507, June 8th; and p. 549, June 22nd, 1920—Abstract.)

The author treats of several of the usual types of wireless circuits by means of vector algebra and equations of the type customarily employed for ordinary alternating current problems. Various coupled valve circuits are included.

751. THE SKIN EFFECT AND FLUX DISTRIBUTION OF CONDUCTORS IN PROXIMITY TO IRON. A. Press. (*Physical Review*, 15, pp. 450—453, May, 1920.)

The author describes some experiments tending to prove that the flux distribution and therefore the skin effect of conductors in iron slots or in proximity to iron approximates very closely to the distribution and skin effect for the same conductors in free air. The solutions previously obtained for windings in air both for low and high frequencies are therefore also applicable to these cases.

752. UNILATERAL CONDUCTIVITY IN CRYSTALS. F. Streintz and A. Wesely (*Physikalische Zeitschrift*, 21, pp. 42—50, January 15th, 1920. *Elektrotechnische Zeitschrift*, 41, p. 400, May 20th, 1920—Abstract. *Science Abstracts*, 23A, pp. 357—358, Abstract No. 912, June 30th, 1920—Abstract.)

A theoretical and experimental paper supporting the view that unilateral conductivity is not due to electrolytic action in liquid films, but is due to the presence of gas films. It is not clear, however, how the gas film causes the unilateral conductivity.

753. DAMPED OSCILLATIONS IN COUPLED CIRCUITS. G. B. Ehrenborg. (*Technical Review*, 6, pp. 264, 467 and 506, March 16th, May 25th, June 8th, 1920—Abstracts. *Science Abstracts*, 23A, pp. 356—357, Abstract No. 910, June 30th, 1920—Abstract.)

See RADIO REVIEW, 1, pp. 220—224, February, 1920; pp. 329—336, April, 1920; pp. 375—380, May, 1920, for the original article.

754. RADIO TUNING CIRCUITS. (*Everyday Engineering Magazine*, 9, pp. 160—161, May, 1920.)

Treats of radio circuits from the view-point of ordinary alternating current reactance and impedance formulæ.

755. DIFFICULTIES IN THE TRANSMISSION AND RECEPTION OF SUSTAINED WAVES. M. Wien. (*Science Abstracts*, 23B, p. 111, Abstract No. 211, February, 1920—Abstract.)

See RADIO REVIEW Abstract No. 271, April, 1920.

756. THE DESIGN OF POULSEN ARC CONVERTERS FOR RADIOTELEGRAPHY. L. F. Fuller. (*Science Abstracts*, 23B, p. 66, Abstract No. 133, January, 1920—Abstract. *L'Elettrotecnica*, 7, pp. 189—191, April 15th, 1920—Abstract.)
See RADIO REVIEW Abstract No. 398, June, 1920.
757. ON THE SELF-INDUCTANCE OF SINGLE LAYER FLAT COILS. S. Butterworth. (*Science Abstracts*, 23A, p. 164, Abstract No. 435—Abstract. *Revue Générale de l'Électricité*, 7, p. 164D, May 22nd, 1920—Abstract.)
See RADIO REVIEW Abstract No. 400, June, 1920.
758. ON THE PHENOMENA PRODUCED BY THE INTERRUPTION OF A STEADY CURRENT IN AN OSCILLATORY CIRCUIT. G. Zickner. (*Science Abstracts*, 23B, p. 197, Abstract No. 392, April, 1920—Abstract.)
See RADIO REVIEW Abstract No. 270, April, 1920.
759. THE CALCULATION OF THE SELF-INDUCTANCE OF RECTANGULAR FLAT COILS. A. Esau. (*Science Abstracts*, 23A, p. 164, Abstract No. 434, March, 1920—Abstract.)
See RADIO REVIEW, 1, Abstract No. 272, April, 1920.
760. PRINCIPLES OF RADIO TRANSMISSION AND RECEPTION WITH ANTENNÆ AND COIL AERIALS. J. H. Dellinger. (*Science Abstracts*, 23B, pp. 65—66, Abstract No. 132, January, 1920—Abstract. *Scientific American*, 122, p. 669, July 19th, 1920—Abstract.)
See RADIO REVIEW Abstract No. 399, June, 1920.
761. ON THE THEORY OF RADIOTELEGRAPHIC AND RADIOTELEPHONIC RECEIVER CIRCUITS. J. F. J. Bethenod. (*Science Abstracts*, 23B, p. 66, Abstract No. 134, January, 1920—Abstract.)
See RADIO REVIEW Abstract No. 398, June, 1920.
762. DETERMINATION OF RATE OF DE-IONISATION OF ELECTRIC ARC VAPOUR. H. G. Cordes. (*Science Abstracts*, 23A, p. 94, Abstract No. 254, February, 1920—Abstract.)
See RADIO REVIEW Abstract No. 397, June, 1920.
763. THERMO-COUPLES FOR ELECTRICAL MEASUREMENTS. J. L. Weatherwax. (*British Patent* 139486, February 25th, 1920. Convention date, February 27th, 1919. Patent not yet accepted but open to inspection.)
Thermo-couples for electrical measurement purposes are described having a heater wire of nickel steel and a thermo-couple constructed between wires of iron and of nickel-copper-alloy containing no zinc. The containing vessel is filled with an inert gas of high thermal conductivity such as hydrogen, argon, nitrogen, etc.
764. DETERMINATION OF DISTRIBUTED CAPACITY AND INDUCTANCE OF A COIL. (*Everyday Engineering Magazine*, 7, p. 158, May, 1920.)
The usual resonance method is described.
765. A DIFFERENTIAL METHOD OF MEASURING CAPACITY AND INDUCTANCE WITH A SENSIBILITY OF 2×10^{-8} . G. Falckenberg. (*Annalen der Physik*, 61, pp. 167—172, January 15th, 1920. *Science Abstracts*, 23A, p. 290, Abstract No. 745, May 31st, 1920—Abstract.)
A thermionic valve oscillator induces current in two independent tuned oscillatory circuits, one of which contains the condenser or inductance under test. These two circuits are coupled to a common tuned tertiary circuit but in opposition so that their joint effect can be reduced to zero. This adjustment is then very sensitive to any variation of the capacity or inductance in one of the intermediate circuits. The condenser in the tertiary circuit is connected to the grid of a two-valve amplifier and a galvanometer is connected across a resistance in the anode

circuit of the second valve, a battery being inserted to compensate for the steady voltage across this resistance. At a frequency of 11,000 with a total capacity of 2,500 cms. one could detect a variation of 0.02 part in a million.

766. A NEW AUDIO-FREQUENCY METER FOR WEAK CURRENTS. K. Wolff. (*Fachbuch Zeitschrift für drahtlose Telegraphie*, 15, pp. 321—326, April, 1920.)

A compensation device of the Campbell type in which the alternating current from a source K (the frequency of which is to be measured) passes through the coil L_1 and capacity C (see Fig. 1). If the mutual inductance M is adjusted so that the sound in the telephone T is a minimum the frequency n is given by the equation $n = 1/2\pi \sqrt{MC}$. Details are given of the design of a compact calibrated instrument made by Seibt suitable for frequencies between 450 and 1,200 per second.

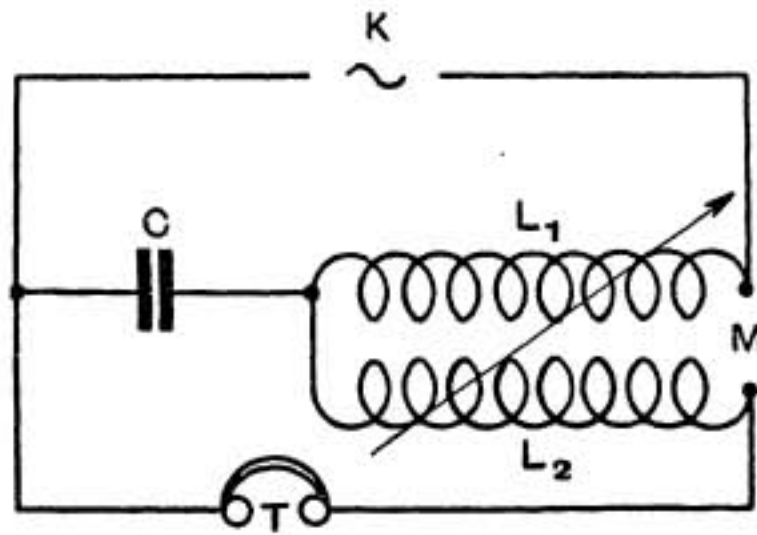

FIG. 1.

767. MEASUREMENT AND COMPARISON OF SIGNAL INTENSITIES IN WIRELESS RECEIVERS. H. de Bellescise. (*Science Abstracts*, 23B, p. 221, Abstract No. 431, April, 1920—Abstract. *Technical Review*, 6, p. 466, May 25th, 1920—Abstract. *Telegraphen- und Fernsprech-Technik*, 9, pp. 18—19, April, 1920—Abstract. *Electrical World*, 76, p. 136, July 17th, 1920—Abstract.)
See RADIO REVIEW Abstract No. 331, May, 1920.
768. A METHOD FOR MEASURING VERY SMALL CAPACITIES AND INDUCTANCES. L. Pungs and G. Preuner. (*Science Abstracts*, 23A, pp. 242—243, Abstract No. 618, April, 1920—Abstract. *Elektrotechnische Zeitschrift*, 41, p. 398, May 20th, 1920—Abstract.)
See RADIO REVIEW Abstract No. 403, June, 1920.
769. THE USE OF AMPLIFIERS FOR MEASURING SMALL DIFFERENCES OF POTENTIAL. A. Blondel. (*Science Abstracts*, 23B, p. 87, Abstract No. 165, February, 1920—Abstract.)
See RADIO REVIEW Abstract No. 186, February, 1920.
770. THE USE OF AMPLIFIERS FOR THE MEASUREMENT OF SMALL DIFFERENCES OF POTENTIAL. R. Depriester. (*Science Abstracts*, 23B, pp. 137—138, Abstract No. 275, March, 1920—Abstract.)
See RADIO REVIEW Abstract No. 212, March, 1920.
771. THE NEW KOLSTER DECREMETER AND WAVEMETER. (*Electrical Experimenter*, 7, p. 663, November, 1919.)
An illustrated description of the apparatus together with instructions for its use.*

* The original description of this instrument may be found in the *Proceedings of the Institute of Radio Engineers*, 3, pp. 29—53, March, 1915.

772. PRODUCING ELECTRIC OSCILLATIONS. R. B. Goldschmidt. (*British Patent* 138366, January 30th, 1920. Convention date, November 18th, 1913. Patent not yet accepted but open to inspection.)

In the usual arrangement of quenched spark transmitters for shock excitation the oscillations in the primary are quenched out by the resistance of the spark gap. In the arrangement here described this quenching is provided by an inductively coupled energy consuming circuit, or by an arrangement for dissipating the energy in the form of hysteresis or eddy current losses in masses of metal. The characteristics of the damping circuits are chosen so that the absorption of power is delayed until after the first maximum amplitude of the primary current.

773. A NEW RADIOTELEGRAPHIC INVENTION. (*Elektrotechnische Zeitschrift*, 40, p. 569, November 6th, 1919. *Revue Générale de l'Électricité*, 7, p. 156D, May 15th, 1920—Abstract.)

Reference is made to an apparatus due to Petersen in which the electric oscillations are obtained by the discharge of condensers without employing a spark gap. It is claimed that a good musical note may be obtained, but no technical details are given.

774. THE POUlsen SYSTEM OF RADIOTELEGRAPHY: HISTORY OF DEVELOPMENT OF ARC METHODS. C. F. Elwell. (*Electrician*, 84, pp. 596—599, May 28th, 1920. *Science Abstracts*, 23B, p. 278, Abstract No. 548, May 31st, 1920—Abstract. *Technical Review*, 6, p. 659, August 3rd, 1920—Abstract.)

The history of the early work on the Poulsen arc starting from Poulsen's first discovery in 1902 is briefly outlined in this article, and the various stations that have been erected by the various companies concerned and by the author of the article are briefly mentioned including a more detailed and illustrated description of the plant at the Honolulu and Arlington stations. Reference is also made to the more recently erected installations at Horsea, Eiffel Tower, Lyons, Rome, Nantes and the stations at present under construction at Leafield and Cairo.

775. A SMALL POUlsen GENERATOR FOR LABORATORY MEASUREMENTS. M. Giddemeister. (*Science Abstracts*, 23A, pp. 96—97, Abstract No. 260, February, 1920—Abstract. *Revue Générale de l'Électricité*, 7, p. 133D, April 24th, 1920—Abstract.)

See RADIO REVIEW Abstract No. 408, June, 1920.

776. AN ELECTRON TUBE TRANSMITTER OF COMPLETELY MODULATED WAVES. L. M. Hull. (*Journal of the Washington Academy of Sciences*, 10, pp. 316—323, June 4th, 1920. *Nature*, 105, pp. 624—625, July 16th, 1920—Abstract.)

The author describes a three-electrode valve transmitter using a low voltage alternating current for heating the filament, and high voltage A.C. from the same source for supplying the plate voltage. By this means a complete modulation of the antenna current from zero to the maximum is obtained at an audible frequency, thus rendering the set suitable for use with non-oscillating receiving circuits for at least limited ranges. A circuit diagram of the arrangement is given together with dimensions of many of the parts for a set using a 500 cycle supply at 150 volts. The author shows that the power output in the antenna is inversely proportional to the product of the antenna capacity and antenna resistance, and that therefore it may be difficult with a given antenna to obtain the maximum output from the tube at short wavelengths if the antenna resistance is low. In the set referred to in the article an overall efficiency of 35 per cent. from the alternator terminals to the antenna was obtained, this figure including the filament heating losses.

An instructive comparison is given between the wave forms of the aerial current arising from such a set supplied with sine wave alternating current in the plate circuit, and the wave form of the aerial current from a spark transmitter. For the same antenna current at a wavelength of 535 metres and with 500 wave-trains per second it is shown that the maximum voltage in the case of the spark transmitter is about thirteen times the maximum voltage with the modulated C.W. transmitter if the decrement of the oscillations in the case of the spark is 0.089, from which it is at once evident that a crystal detector should give a louder response to signals from the spark set.

777. THERMIONIC VALVE OSCILLATION GENERATORS. E. H. Colpitts. (*British Patent*, 141060, March 31st, 1920. Convention date, February 1st, 1918. Patent not yet accepted but open to inspection.)

The so-called "Colpitts" oscillation generator circuit is described in this specification. The arrangement is indicated in Fig. 2, which shows a single inductance L connected between the plate and grid of the valve in the oscillation circuit, the condensers C_1 and C_2 being connected in series as shown, while the leak resistance R is to ensure that the grid potential remains the same as that of the filament. The condenser C is merely for blocking purposes. For transmission purposes the aerial circuit may be coupled at T as indicated or alternatively the capacity C_1 may be replaced by the aerial capacity, the filament of the valve being connected to earth so that the condenser C_2 forms part of the aerial circuit.

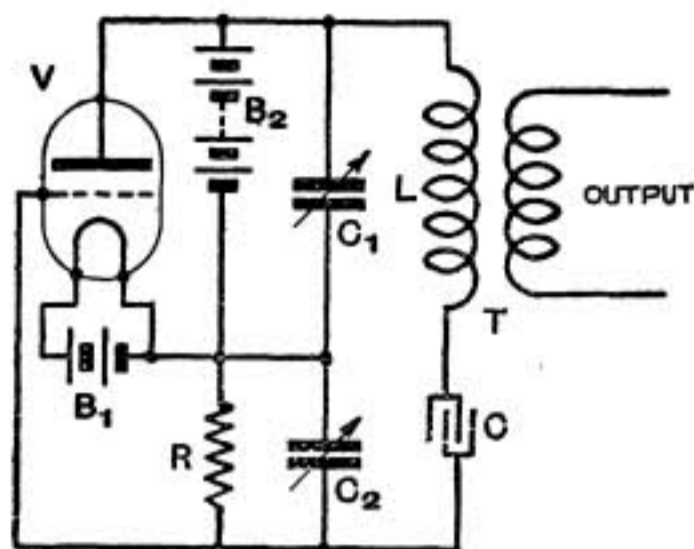

FIG. 2.

778. EDUCATIONAL APPARATUS FOR CONTINUOUS WAVE SENDING AND RECEIVING. (*Telefunken Zeitung*, 3, No. 18, pp. 75—77, October, 1919.)

An illustrated description of a board with all the various valve circuits and accessories plainly shown and labelled.

779. HIGH-FREQUENCY ALTERNATOR OR ARC GENERATOR? (*Telefunken Zeitung*, 4, No. 20, pp. 16—18, May, 1920.)

An article written to show that the former method is superior to the latter.

780. HIGH FREQUENCY INDUCTOR ALTERNATORS. O. Billieux. (*British Patent* 140769, March 22nd, 1920. Convention date, November 22nd, 1917; and *British Patent* 140773, March 22nd, 1920. Convention date, January 24th, 1918. Patents not yet accepted but open to inspection.)

Various arrangements of high frequency alternators are described, in particular ones involving the use of two discs rotating at equal speeds in opposite directions and provided with magnetic teeth interspersed with non-magnetic teeth around their periphery. A single homopolar winding may be provided on the stator together with an armature winding around the stator teeth which face the teeth of each rotating disc. Alternatively when the width of the teeth is equal to the width of the space between them a variable reluctance type of machine is obtained so that the field winding may be dispensed with and the armature winding used for the excitation as well as for the high frequency current. Various special arrangements of teeth are also described leading to modifications of the machine and in one case with the suppression of the stator entirely and with the use of an exciting winding mounted on one of the rotating discs. See also RADIO REVIEW Abstract No. 410, June, 1920.

781. HIGH-FREQUENCY ALTERNATORS. M. Latour. (*Proceedings of the Institute of Radio Engineers*, 8, pp. 220—237, June, 1920. *Electrical World*, 76, p. 33, June 3rd, 1920—Abstract.)

Partly a reproduction of a communication presented to the Société Française des Électriciens.*

See also RADIO REVIEW, 1, p. 491, July, 1920, where a lecture covering the same subject-matter has been abstracted.

* *Bulletin de la Société Française des Électriciens*, 9, pp. 97—114, February, 1919.

782. MODERN RADIO TRANSMITTERS OF UNDAMPED OSCILLATIONS. G. von Arco. (*Science Abstracts*, 23B, p. 163, Abstract No. 329, March, 1920—Abstract.)
See RADIO REVIEW Abstract No. 281, April, 1920.

783. HIGH FREQUENCY TELEPHONY. G. Beauvais. (*La T.S.F. Moderne*, I, pp. 4—7, April, 1920.)

The application of radio telephone transmitters to communication along telephone lines using high frequency carrier currents is dealt with, and in particular a method of modulation in which the modulating valve V_1 is connected in parallel with the grid condenser C of the oscillating valve V_2 . It thus replaces the grid leak by the controlled plate-filament resistance of the modulating valve. See Fig. 3.

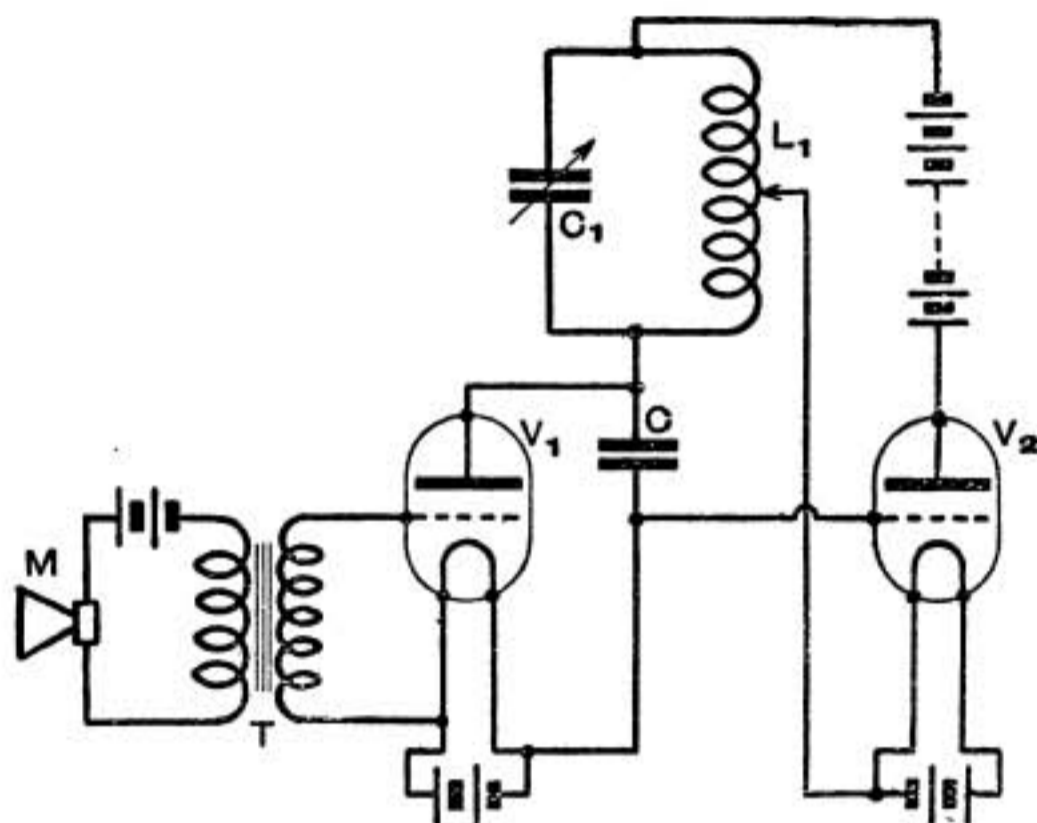

FIG. 3.

784. MODULATION ARRANGEMENTS FOR THERMIONIC OSCILLATION GENERATORS. E. H. Colpitts. (*British Patent* 141047, March 30th, 1920. Convention date, May 8th, 1914. Patent not yet accepted but open to inspection.)

In a thermionic valve oscillation generator provided with a retro-active coupling between the anode and the grid circuits modulation of the high frequency oscillations is arranged by means of a microphone coupled between the grid and filament of the valve and hence in parallel with the retro-active coupling. Other modifications are described whereby two or more valves may be used to increase the output.

785. APPLICATION OF THERMIONIC AMPLIFIERS AS TELEPHONIC REPEATERS. C. Robinson and R. M. Chamney. (*Institution of Post Office Electrical Engineers*, Paper No. 76, pp. 1—128, 1919. *Science Abstracts*, 23B, p. 174, Abstract No. 349, March, 1920.)

The first of these two papers describes the work done in the British Post Office on this subject up to 1917. After an outline of conduction through gases the authors give details of the Cooper Hewitt and the Lieben magnetically controlled tubes and accounts of the Audion, the Lieben-Reisz relay, the Round tube, the Pliotron with particulars of tubes developed by the Post Office. Experimental methods and results are described.

The second paper describes the development since 1917. After a reference to the theory of

the "hard" tube the authors state that this type has now replaced the soft type, the pattern now used being that known as the French valve. Complete characteristics are given for this type and its performance is discussed in detail. Equations for determining the magnification effected are given. The determination of the best ratio for the transformers is discussed and particulars are supplied of the variation of the magnification with transformation ratio, with grid and plate voltages and with the input.

786. TELEPHONE TRANSMITTERS. B. F. Miessner. (*British Patent* 140070, March 8th, 1920. Convention date, March 12th, 1919. Patent not yet accepted but open to inspection.)

A microphone transmitter is described particularly adapted for use on aircraft. The diaphragm casing is arranged so that the diaphragm itself is equally exposed on both sides. Engine noises, etc., may thus be eliminated whilst speech which impinges on one side of the diaphragm only is transmitted.

787. TELEPHONE REPEATERS. M. Latour. (*British Patent* 140123, September 5th, 1918. Convention date, September 5th, 1917. Also *British Patent* 140133, October 26th, 1918. Convention date, October 3rd, 1917. Patents accepted March 25th, 1920.)

These specifications deal with three-electrode valve amplifiers for telephone lines in which the filament is switched on and off by a relay operated by the calling signal. Means may also be provided for indicating at the operators' stations when the filament circuit of the relay has been opened.

788. TRANSMITTING SYSTEM. Société le Matériel Téléphonique. (*French Patent* 500655, June 12th, 1919. Published March 20th, 1920.)

In a method of modulating high frequency carrier oscillations, the carrier oscillations are impressed symmetrically on a pair of circuits which are influenced differentially by the signal currents, the modulated oscillations being impressed differentially on the out-going circuits. For further particulars, see *British Patent* 130219.*

789. WIRELESS TELEPHONY AND RAILWAY STRIKES. (*Wireless World*, 8, p. 23, April 3rd, 1920.)

An account is given of a wireless telephone network set up between London, Wellingboro', Birmingham, Leicester, Derby, Rotherham and Leeds during the railway strike of September and October, 1919, in order to ensure a reliable means of communication between those places.

790. AN OSCILLION RADIO TELEPHONE AND TELEGRAPH. (*Electrical Experimenter*, 7, pp. 908 and 954, January, 1920.)

A panel type radio telephone set manufactured by the de Forest Radio Company is described and illustrated.

791. THE PRESENT POSITION OF WIRELESS TELEPHONY. K. Heffner. (*Telefunken Zeitung*, 3, No. 18, pp. 67—72, October, 1919.)

A description of the methods of duplex telephony and a discussion of the relative advantages of wire and wireless methods.

792. TRANSATLANTIC WIRELESS TELEPHONY. J. A. Fleming. (*Annales des Postes, Télégraphes et Téléphones*, 9, pp. 177—178, March, 1920.)

See *RADIO REVIEW* Abstract No. 135, January, 1920.

793. SIMULTANEOUS TRANSMISSION AND RECEPTION IN RADIOTELEPHONY. N. Marumo. (*Proceedings of the Institute of Radio Engineers*, 8, pp. 199—219, June, 1920. *Electrical World*, 76, p. 86, July 10th, 1920—Abstract.)

In attacking the problem of simultaneous transmission and reception, great difficulty is

* *RADIO REVIEW* Abstract No. 35, November, 1919.

experienced in excluding induction into the receiving circuit from its own transmitter. Until recently the only practical duplex system seems to have been that of the Marconi Company in which the sending and receiving stations must be several miles apart. Recently a method has been devised by Dr. W. Torikata and his staff in the Imperial Japanese Electro-Technical Laboratory, Tokyo, in which only one antenna is required. The arrangement which can also be adapted to "wired wireless" is illustrated in Fig. 4.

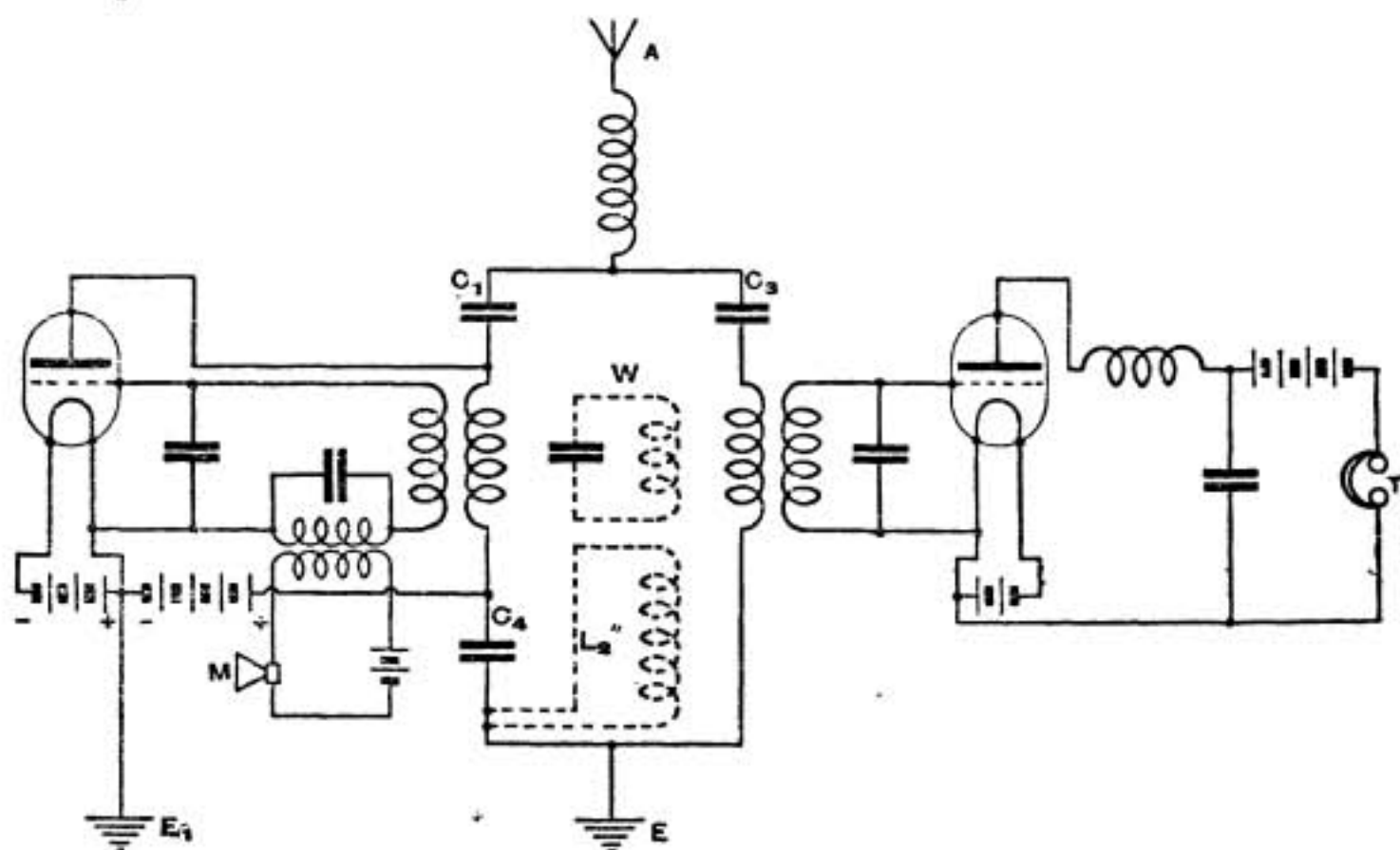

FIG. 4.

The antenna is of the divided branch type with a supplementary balancing coil L_2 and absorbing circuit W for use if necessary. The sending wavelength is adjusted to one of the natural wavelengths of the system and the receiving wavelength to the other. The impedances of the three branches of the antenna circuit are adjusted (a) to minimise the current flowing in the receiving branch due to the sending current and (b) to make the externally received current as large as possible. The conditions for obtaining these desiderata are investigated mathematically, but even though the adjustments so indicated are made it is practically impossible to get rid of the effect of the transmitter on the receiver without the use of the balancing coil.

Full diagrams of applications of the above circuit to combined wired wave telephony and telegraphy are given in which the use of a single oscillation generator for a number of stations is shown to be possible.

794. **DUPLEX WIRELESS SIGNALLING.** R. Whiddington and P. P. Eckersley.
(*British Patent 134341*, November 4th, 1918. Patent accepted November 4th, 1919.)

The arrangement consists in providing the receiving aerial with two branches one of which contains a capacity and inductance to tune it to the frequency of the signal to be received and the other containing a capacity only so that its impedance is different to that of the first branch. Oscillations of frequency differing from those which it is desired to receive will then pass to earth by the second branch having the smaller impedance and so will not affect the receiver which is coupled to the inductance of the first branch. The arrangement is particularly applicable for preventing interference from the adjacent transmitter in duplex work.*

* See also RADIO REVIEW Abstract No. 492, July, 1920, where a somewhat similar duplex arrangement is described.

795. A NEW AUTOMATIC TELEGRAPH. (*Electrician*, 85, p. 62, July 9th, 1920.)

A new automatic transmitting apparatus for wireless or ordinary telegraph purposes is briefly described and illustrated. The apparatus is provided with a single plug and with sixty jacks into any one of which the plug may be inserted. Each jack is provided with a name plate indicating the particular signal to which it refers. To operate the apparatus the plug is inserted into the jack corresponding to the message that it is desired to send and a lever at the side is pressed down, when that message will be transmitted automatically prefixed by the code letter or number of the instrument. Provision is also made for the transmission of "S.O.S." messages. The arrangement is particularly suitable for use on aircraft and also for small vessels not carrying a certificated wireless operator.

796. VACUUM TUBES. Siemens and Halske Akt.-Ges. (*British Patent* 134542, October 30th, 1919. Convention date, June 21st, 1916. Patent not yet accepted but open to inspection.)

In the arrangement described two intermediate electrodes are interposed between the filament and the plate and the valve, one of them being maintained at a negative potential and the other at a positive one. The suggested arrangement is indicated in Fig. 5 in which F is the filament and P the plate while the zig-zag shown in end view at G₁ forms one of the intermediate electrodes which is placed inside the second intermediate electrode G₂ which is in the form of a wire grid wound round the glass rod support A B. The plate P may also be mechanically supported from this glass rod frame as indicated.

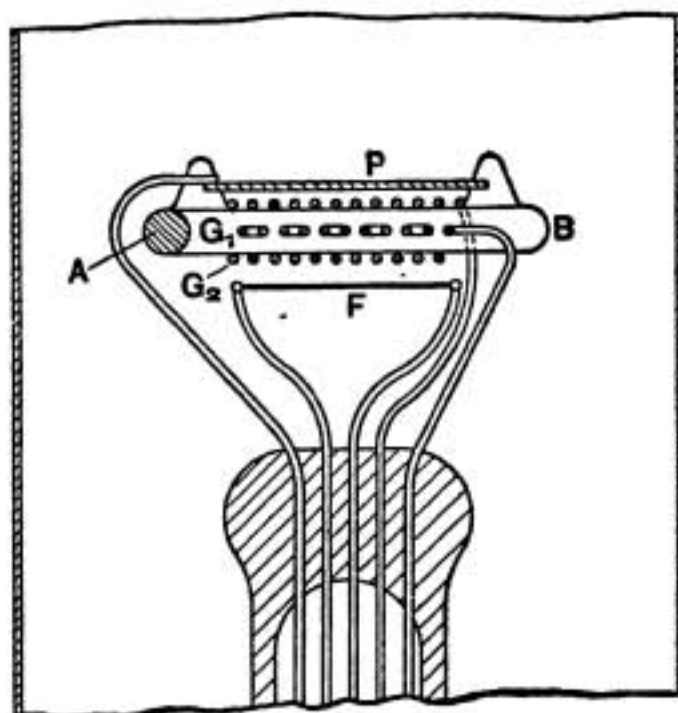

FIG. 5.

797. VACUUM TUBES. G. Holst and E. Oosterhuis. (*British Patent* 137281, December 22nd, 1919. Convention date, December 31st, 1918. Patent not yet accepted but open to inspection.)

It is suggested that the anode for a thermionic valve for generating oscillations should be made hollow so that water or gas may be circulated through the inner hollow space. An electric heater may also be inserted to expel gases from the material of the anode during exhaustion of the valve.

798. ELECTRONIC AND IONIC OSCILLATIONS IN THERMIONIC VALVES. G. W. O. Howe. (*Technical Review*, 6, p. 690, August 17th, 1920—Abstract.)

See RADIO REVIEW, 1, pp. 434—436, June, 1920.

799. SOME NOTES ON VACUUM TUBES. J. H. Morecroft. (*Proceedings of the Institute of Radio Engineers*, 8, pp. 239—260, June, 1920. *Electrical World*, 76, p. 33, July 3rd, 1920—Abstract.)

An attempt to reconcile the experimentally obtained characteristics of vacuum tubes with the general theory as developed by Langmuir, van der Bijl and others. The general expression for the anode current I_p of a tube is

$$I_p = \alpha (E_p + \mu_0 E_g + \epsilon)^x$$

where E_p and E_g are the anode and grid voltages respectively and α, μ_0, ϵ and x are constants. One of the factors which determine the value of ϵ is the electronic emission velocity which, increasing with increase of temperature, is evidently greater for tungsten filaments than for oxide filaments. To find how ϵ varied with the temperature the relation between filament current and anode current in a diode was obtained for zero anode voltage (the anode being connected to the negative end of the filament). The anode current increased rapidly with increase of filament temperature but was shown to be extremely small compared with the current obtained when the anode voltage is increased to unity.

The value of the exponent x has been given as $\frac{3}{2}$ and 2, the former a theoretically derived value and the latter experimentally obtained. For certain low anode voltage tubes it is shown that not only does the value not lie between $\frac{3}{2}$ and 2 but that it also varies with the anode voltage, decreasing with increase of the latter. One of the principal reasons for the variation of the exponent is that there are different voltages between different parts of the filament and the anode since the large change in x does not occur if the surface emitting the electrons is an equipotential surface.*

The distortion effect in an amplifier tube has been considered by van der Bijl who showed that for an impressed grid E.M.F. of $E_g \sin \omega t$,

$$I_p = \alpha (\tau E_p + E_c + \epsilon)^2 + 2\alpha (\tau E_p + E_c + \epsilon) E_g \sin \omega t + \frac{\alpha E_g^2}{2} (\cos 2\omega t + \pi) + \frac{\alpha E_g^3}{2}$$

The third term represents distortion and may be made as small as desired by adding sufficient resistance in the anode circuit. As the coefficient of the third and fourth terms are the same and as the latter is shown on a direct current instrument in the anode circuit, the distortion can be determined. To do this the variation between D.C. instrument reading and impressed sinusoidal grid voltage was determined. The effect of adding resistance in the anode circuit was found to be in accordance with van der Bijl's theoretical discussion.

The internal capacities and conductances of a number of tubes were measured by a Wheatstone bridge method. The capacities were found to depend on the connections of the electrodes and were found to be within the following ranges:—

	Capacity in micro-microfarads.
Grid to filament, anode free	10.4 to 55.6
Grid to plate, filament free	14.4 to 22.0
Grid to plate and filament, these being connected together.	17.0 to 69.6

Only the smallest increases in these capacities were found when the filament was heated. If one side of the filament is earthed the capacity of the grid-ground circuit, when the tube is operating with a normal amount of resistance or reactance in the anode circuit is from 5 to 10 times as much as the geometrical capacity of this circuit, and the amount of this increase is controlled by the capacity between the grid and plate.

* See *Physical Review*, 8, p. 563.

Some experiments on the detecting action of a tube without grid condenser seem to prove that the asymmetry of the grid-filament circuit plays an unimportant part in this action.

800. ON THE THEORY OF IONISATION BY COLLISION. P. O. Pedersen.
(*Jahrbuch Zeitschrift für drahtlose Telegraphie*, 15, pp. 289—299, April, 1920. *Philosophical Magazine*, 40, pp. 129—137, July, 1920.)

A theoretical discussion of the case of the ionisation produced by collision in gas between two parallel electrodes. Various corrections are made in the theory originally given by Townsend. The latter from his experiments on atmospheric air had deduced a value of 20 volts for the ionising potential. The same experimental results with the corrected theory yield the value of 16 volts which is nearer the value of 10 volts obtained by Franck and Hertz by the more direct method.

The main assumptions in the present treatment (originally due to N. R. Campbell who failed to give an exact solution) are as follows:—

(a) An electron will produce a fresh pair of ions when colliding with a neutral molecule if previous to the collision its velocity v satisfies the relation

$$v \geq v_0 = \sqrt{\frac{2e}{m}} \cdot V_0$$

where e/m is the ratio of charge to mass of the electron, and V_0 a constant voltage for the particular neutral molecules.

(b) Collisions between electrons and molecules take place unelastically so that the velocity of the electron after the collision is zero.

(c) The velocity of the liberated electrons is zero.

(d) The velocity of the electrons due to the electric field is so great that the thermal velocities of the electrons and the molecules may be disregarded.

801. IONIC OSCILLATIONS IN THREE-ELECTRODE THERMIONIC VALVES. R. Whiddington.
(*Science Abstracts*, 23B, p. 69, Abstract No. 140, January, 1920—Abstract.)
See RADIO REVIEW Abstract No. 427, June, 1920.

802. THE VACUUM TUBE AS A GENERATOR OF ALTERNATING CURRENT POWER. J. H. Morecroft and H. T. Friis. (*Science Abstracts*, 23B, p. 67, Abstract No. 136, January, 1920—Abstract. *Revue Générale de l'Électricité*, 7, p. 198D, June 19th, 1920—Abstract.)
See RADIO REVIEW Abstract No. 417, June, 1920.

803. DETERMINATION OF THE OUTPUT CHARACTERISTICS OF ELECTRON TUBE GENERATORS. L. M. Hull. (*Science Abstracts*, 23B, p. 111, Abstract No. 209, February, 1920—Abstract. *Jahrbuch Zeitschrift für drahtlose Telegraphie*, 16, pp. 70—71, July, 1920—Abstract. *Electrical World*, 76, p. 137, July 12th, 1920—Abstract.)
See RADIO REVIEW Abstract No. 420, June, 1920.

804. AMPLIFICATION CONSTANTS AND INTERNAL RESISTANCES OF THREE-ELECTRODE VALVES. J. M. Miller. (*Technical Review*, 6, p. 548, June 22nd, 1920—Abstract.)
See RADIO REVIEW, 1, p. 454, Abstract No. 426, June, 1920.

805. THE THERMIONIC VALVE IN WIRELESS TELEGRAPHY AND TELEPHONY. J. A. Fleming. (*Engineering*, 109, p. 760, June 4th, 1920. *Electrician*, 84, p. 646, June 11th, 1920—Abstract.)

Abstract of lecture delivered at the Royal Institution on May 21st, 1920. The lecturer briefly reviewed the development of the two- and three-electrode valves from the early experiments on the Edison effect and led up to its modern use in wireless work. A special four-anode valve was also described for use as a call device in wireless reception. The four anodes surrounded a central filament which was heated by a battery and two of them were connected across a resistance of 20,000 ohms joined in the plate circuit of a detecting valve coupled to the receiving aerial. The remaining two anodes at right angles to the others were connected together and in series with a relay to the positive terminal of the filament heating

battery. When a signal is received the plate current of the detecting valve is decreased with the result that a current is enabled to flow to two of the anodes of the special valve thus operating the relay.

806 VACUUM-TUBE CIRCUITS. P. H. Boucheron. (*Electrical Experimenter*, 7, pp. 1028—1029 and 1084—1086, February, 1920.)

A *resumé* of a number of circuits using a three-electrode valve for reception purposes. The circuits considered include simple detection circuits, heterodyne regenerative circuits, combined amplifier and crystal detector, two-stage and multi-stage amplifiers, telegraph and telephone transmission circuits.

807. THE USE OF AUDIONS OR THREE-ELECTRODE LAMPS DURING THE WAR. G. Ferrié. (*Annales des Postes, Télégraphes et Téléphones*, 9, pp. 143—148, March, 1920.)

See RADIO REVIEW Abstract No. 424, June, 1920.

808. TECHNIQUE OF DISCHARGE TUBES. F. Schroter. (*Elektrotechnische Zeitschrift*, 40, pp. 685—687, December 25th, 1919. *Revue Générale de l'Électricité*, 7, p. 198D, June 19th, 1920—Abstract.)

This article deals with the use of discharge tubes containing rarefied gas as alternating current rectifiers. Formulæ are given for the current flow through such tubes and some practical forms are illustrated.

809. ELECTRIC CURRENT RECTIFIERS. Siemens Schuckertwerke. (*British Patent* 142465, April 26th, 1920. Convention date, February 7th, 1917. Patent not yet accepted but open to inspection.)

An arrangement of a series of rectifying valves and condensers identical with that described in RADIO REVIEW Abstract No. 117, January, 1920. (See also RADIO REVIEW, 1, p. 264, February, 1920, for correction to the circuit diagram in Abstract No. 117.)

810. DIRECTIONAL WIRELESS RECEPTION. J. Robinson. (*British Patent* 134342, November 4th, 1918. Patent accepted November 4th, 1919.)

In order to avoid missing any parts of a message that may be received at a direction finding station when working the frame aerials (or radiogoniometer) at their minimum position in order to determine the direction of the incoming signal, it is suggested that the same signals should be picked up on a non-directive aerial and combined with that received on the directive aerial, so that in the minimum position of the receiving frame (or radiogoniometer) the signal strength does not fall to zero but is merely reduced to a minimum value. The non-directive aerial may for example consist of a pair of fixed coils at right angles to each other or may be one of a number of other arrangements described in the specification.

811. DIRECTIVE WIRELESS SIGNALLING. C. S. Franklin. (*British Patent* 140538, January 17th, 1919. Patent accepted April 1st, 1920.)

In an arrangement for directional signalling using two aerials spaced a known fraction of a wavelength apart each aerial is provided with its amplifying valve the grid circuit of which is supplied through a tuned circuit from a central control valve which generates the oscillations. The dynamo which supplies the control valve also feeds the amplifying valves for each aerial through a special wire provided for that purpose between the central station and the two aerials. The phase relation of the currents in the two aerials may be controlled by means of the tuned circuits coupling the control valve with the amplifying valves.

812. "ON THE GONIOMETRIC FUNCTIONS APPLICABLE TO DIRECTIVE AERIALS." J. B. Brady; G. W. Pickard; A. Blondel. (*Radio Review*, 1, pp. 256—258, February, 1920.)

Correspondence relative to the paper by A. Blondel with the above title.*

* See RADIO REVIEW, 1, pp. 1—10, October, 1919; pp. 58—66, November, 1919; pp. 110—123, December, 1919.

813. WIRELESS TELEGRAPHY IN MODERN NAVIGATION. O. Nairz. (*Telefunken Zeitung*, 3, No. 18, pp. 60—62, October, 1919.)

A short description of the use of directional wireless.

814. DIRECTION AND POSITION FINDING. H. J. Round. (*Telegraphen- und Fernsprech-Technik*, 9, p. 34, May, 1920—Abstract.)

See RADIO REVIEW Abstract No. 507, July, 1920.

815. NEW EXPERIMENTS ON SPARK RADIOTELEGRAPHIC DIRECTIVE TRANSMISSION. F. Kiebitz. (*Jahrbuch Zeitschrift für drahtlose Telegraphie*, 15, pp. 299—310, April, 1920.)

An account of experiments, still in progress, on directive transmission using twin pairs of vertical antennæ similarly excited. In the simple case, if one pair is used the maximum signals are received in the plane containing the two antennæ while the minimum signals are received in a plane at right angles to this, midway between the antennæ.

A simple application of such directive transmission is in the controlling and guiding of a distant vessel along a particular course. For such a case the direction of minimum transmission is most defined.

Various further applications can be made of this principle if two pairs of antennæ are used. A simple scheme is shown in Fig. 6 in which AA represent one pair of antennæ and NN the other, the angle between AA and NN being small. A convenient scheme is for the two N antennæ to send out the Morse letter "N" and for the A antennæ to send out simultaneously the Morse letter "A." Thus a vessel or flying machine

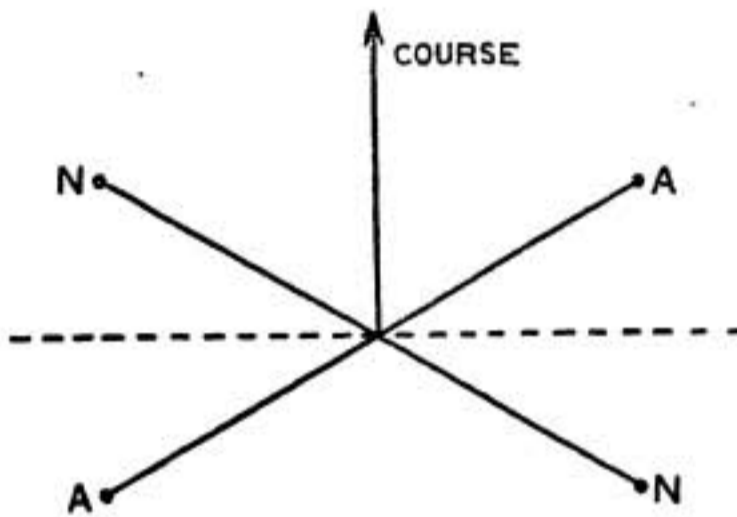

FIG. 6.

following the course hears both equally well but on deviating from the course hears one stronger.

Experiments with a slight variation of this arrangement (with one antenna AN taking the place of the two A and N on the side of the course) have been carried out to check the utility of the scheme over a known course. It was found that the null point for one pair of antenna sending was about 30 metres broad at a distance of $3\frac{1}{2}$ km. (ten times the wavelength) and the direction about 10 degrees north of the actual theoretical direction. When both antennæ were sending the signals which indicated the course were "12 metres broad" at a distance of 3.5 km. This corresponds to an angle of about 10 minutes.

816. ATMOSPHERIC ELECTRICITY. W. F. G. Swann. (*Journal of the Franklin Institute*, 188, pp. 577—606, November, 1919.)

The author discusses various phenomena of atmospheric electricity and of atmospheric electric measurements including potential gradient, conductivity, etc., and discusses in considerable detail the question of the ionisation of the atmosphere, and experiments which have indicated that above a height of 700 metres from the earth's surface the measured value for the ionisation commences to increase, until at an altitude of 9 km. the average ionisation is from three to four times that at the earth's surface and is increasing very rapidly with increase of altitude. He therefore concludes that this ionisation at high altitudes is not due to radioactive material in the earth's surface but to X-rays or γ rays set up by the impact of negatively charged particles or electrons with the gases of the upper atmosphere. This γ radiation would have very great penetrating and ionising powers. It is further stated that the production of the aurora would also require the impact of electrons or charged particles having a speed sufficiently high for the production of this penetrating radiation.

817. THE LENGTHS OF PATH OF THE NEWTONIAN LUMINOUS RADIATION AND THE ZONES OF SILENCE IN DAMPED RADIO SIGNALS. G. Sagnac. (*Comptes Rendus*, 170, pp. 800—803, March 29th, 1920. *Revue Scientifique*, 58, p. 222, April 10th, 1920—Abstract. *Bulletin de la Société Belge des Électriciens*, 34, p. 137, July, 1920—Abstract.)

The author refers to some extensive experiments carried out by Admiral H. B. Jackson in 1895 in which zones of silence were observed in the case of radio transmission between three ships in line. From the distance between these zones of silence he deduced that the radial component of the speed of the earth through the ether must be of the order of 400 km. per second and is therefore much greater than the earth's orbital velocity and approaches the observed velocities of the largest stars.

818. RADIOTELEGRAPHY DURING THE SOLAR ECLIPSE OF MAY 29TH. (*Nature*, 104, pp. 323—324, November 20th, 1919. *Science Abstracts*, 23B, pp. 68—69, Abstract No. 139, January, 1920—Abstract.)

See RADIO REVIEW, 1, pp. 24—26, October, 1919. Also RADIO REVIEW Abstracts Nos. 302, April, 1920, and 364, May, 1920.

819. WIRELESS COMMUNICATION BETWEEN HOLLAND AND INDIA. (*Elektrotechnische Zeitschrift*, 41, p. 439, June 3rd, 1920.)

Some particulars are given as to the power and equipment of the installations.*

820. A CONTRIBUTION TO THE STUDY OF SUBMARINE RADIO COMMUNICATION. L. Bouthillon. (*Revue Générale de l'Électricité*, 7, pp. 696—700, May 20th, 1920. *Technical Review*, 6, pp. 588—589, July 6th, 1920—Abstract.)

A brief *resumé* is first given of previous work and of publications dealing with loop and other aerial arrangements for radio communication with submarines,† while the second part of the article is devoted to the theoretical consideration of the attenuation of the electromagnetic wave as it penetrates to various depths into sea water. The amplitude of an electromagnetic field at a depth z in any given medium is given by $I = I_0 e^{-dz}$ where z is the depth and d is a damping coefficient for which the complete expression is given by Zenneck. The author shows that in the case where the material has considerable conductivity, as in the case of sea water, the expression for d becomes $2\sqrt{\omega \sqrt{\pi} \cdot \sigma_2}$ where ω is $2\pi \times$ the wave frequency, and σ_2 is the specific conductivity of the water. Hence the wave amplitude will be reduced in the ratio of $1/\epsilon$ at a depth of 50 cms. for a wavelength of 300 metres, at a depth of 160 cms. for a wavelength of 3,000 metres and at a depth of 500 cms. for a wavelength of 30,000 metres. Curves and tables are also given from which may be ascertained the equivalent distance of transmission over the surface of the sea at which the signal strength will be the same as that obtained at various depths below the surface and at various distances from the transmitter. These curves emphasise the great advantages of long wavelengths for such purposes.

821. THE EVOLUTION OF THE LOW FREQUENCY AMPLIFIER DURING THE WAR. H. Dubosq. (*La T.S.F. Moderne*, 1, pp. 11—18, April, 1920; pp. 41—47, May, 1920.)

This article traces the evolution of the low frequency amplifiers used by the French army. Illustrations are given of the various types together with circuit diagrams of the arrangements.

The second part of this article deals with the amplifiers designated by 2-bis, 3-bis, the famous 3-ter and the No. 4. Connection diagrams are given for each of these arrangements and photographic illustrations of the complete apparatus. A few particulars are also included of the windings used in inter-valve transformers. In the well-known 3-ter type of amplifier three valves are employed the first one of which is provided with a change-over switch so that

* See RADIO REVIEW Abstracts No. 304, April, 1920, and No. 514, July, 1920.

† See for example RADIO REVIEW Abstracts No. 85, December, 1919, and No. 682, August, 1920.

it may serve either as an ordinary detecting valve with a grid condenser and leak or as a simple low frequency amplifying valve with an iron core input transformer. The remaining two valves are low frequency amplifiers with transformer couplings. The type 4 amplifier differs from the type 3-ter by the addition of a telephone transformer in the output circuit of the last valve. Both these types were arranged for either wireless reception or for earth current signalling.

822. A SEPARATE OSCILLATOR FOR C.W. RECEPTION. (*Wireless World*, 8, pp. 173—174, May 29th, 1920; and pp. 209—212, June 12th, 1920.)

Constructional details are given for a simple inductively coupled separate heterodyne oscillator using a V.24 valve with pancake type inductances in the anode and grid circuits.

823. CRYSTAL DETECTOR. L. Bordat. (*French Patent* 500579, June 10th, 1919. Published March 17th, 1920.)

In a crystal detector apparatus for wireless telegraphy, the characteristic feature is that the parts are jointed so that the crystal carrier and the needle carrier can be arranged in any position in relation to each other.

824. CRYSTAL DETECTOR. V. J. Brochard. (*French Patent* 501156, November 19th, 1918. Published April 6th, 1920.)

For further particulars, see British Patent 139904.*

825. CRYSTAL DETECTORS. V. J. Brochard. (*British Patent* 139904, April 2nd, 1919. Patent accepted March 18th, 1920.)

A special construction for a totally enclosed crystal detector is described in which the whole detector is mounted in an insulating tube filled with a soft insulating material.

826. MOVING IRON RECORDING GALVANOMETERS. H. Abraham and E. Bloch. (*Comptes Rendus*, 169, pp. 171—174, July 28th, 1919.)

The authors describe the construction of moving iron galvanometers which may be adapted for use either as recording oscillographs, relays or mirror oscillographs. The special features are that the moving iron armature is so placed relative to the fixed magnetic field that it is symmetrically magnetised with respect to its axis of rotation. The control is then obtained by means of a spring. The magnetic circuit for the variable currents passing through the windings is closed through the pole pieces and the armature without passing through the body of the permanent magnet. Accidental demagnetisation is thus avoided. A sensitiveness of from 1 to 10 millimetres per milliamperere may be obtained.

827. AN AUTOMATIC CALL DEVICE. B. Binyon. (*Wireless World*, 8, pp. 158—167, May 29th, 1920. *Technical Review*, 6, p. 624, July 20th, 1920—Abstract.)

Paper read before the Wireless Society of London—see RADIO REVIEW, 1, pp. 436—437, June, 1920, for abstract. The full report of the discussion is also included with the original paper, which contains illustrations of the complete apparatus and of some of its parts.

828. RADIOTELEGRAPHIC FILTER OR X-STOPPER. (*Revue Générale de l'Électricité*, 6, p. 610, November 1st, 1919. Abstracted from the *Journal of the Franklin Institute*, 187, p. 512, 1919.)

Various forms of apparatus are described for eliminating atmospheric disturbance by acoustic resonance to the group frequency of the incoming signals.

829. THERMIONIC AMPLIFIERS. H. D. Arnold. (*British Patent* 140829, March 27th, 1920. Convention date, September 3rd, 1915. Patent not yet accepted but open to inspection.)

The arrangement described is designed to act as a limiter for incoming impulses so that the strength of disturbances is reduced to a value not exceeding that of the signals. As distinct from the ordinary arrangements the incoming impulses are first amplified so that as far as

* RADIO REVIEW Abstract No. 825.

possible uniform amplification is obtained irrespective of the voltage of the impulse. In Fig. 7 the valve V_1 acts simply as an amplifying valve and its output circuit including the coils L_1 and L_2 is provided with a reaction coupling L_2 back to the grid circuit L so as to exactly neutralise the natural coupling through the grid-plate capacity of the valve. V_2 is the detecting valve and the output from this valve is passed to the two low frequency amplifying valves

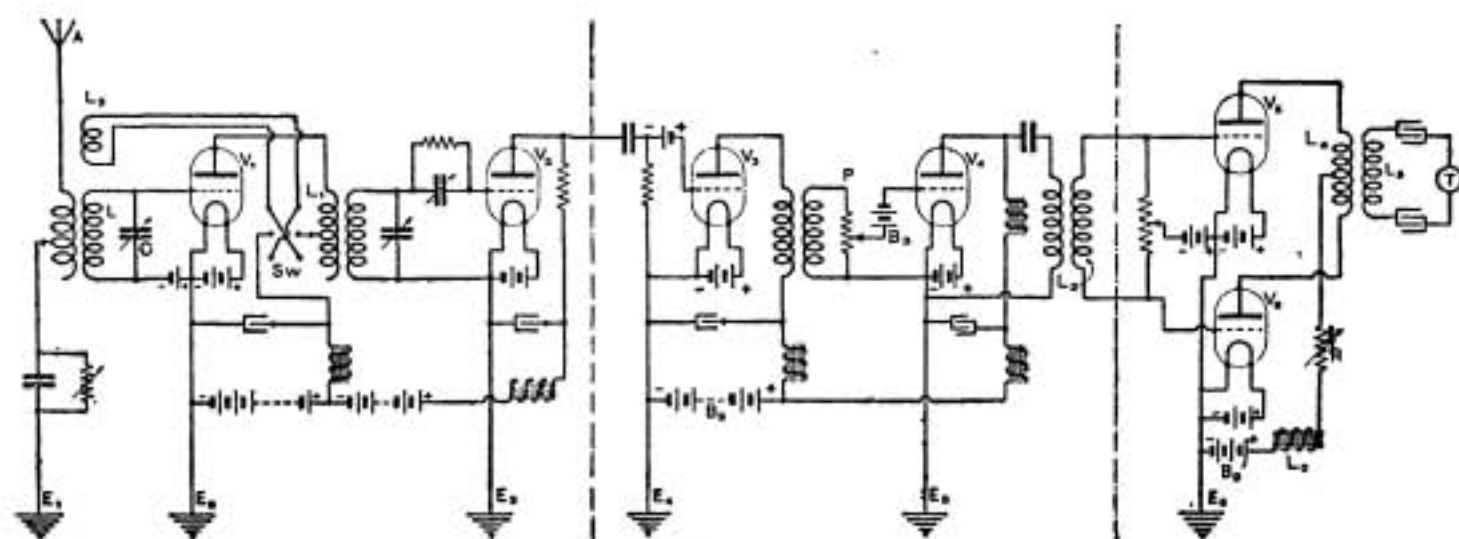

FIG. 7.

V_3 V_4 which are inductively coupled as shown, the amount of amplification being controlled by the potentiometer P . The limiting effect takes place in the last stage which includes the two valves V_5 V_6 connected in opposition in the circuit L_3 L_4 . The choke coil L_0 serves to maintain as constant as possible the output from the battery B_2 while the resistance R also tends to limit the plate currents of these valves V_5 V_6 . The receiving instrument T is coupled through the differential transformer L_4 L_5 to this last amplification stage. The limiting action is secured by adjustment of the voltage of B_2 so that the normal current that can pass through V_5 V_6 is only just greater than the amplitude of the signals to be received. The receipt of a more powerful impulse will then cause the plate current of one valve to be reduced to zero while the other one cannot be increased to more than its saturation value so that the signal strength in T cannot increase beyond the ordinary signal strength.*

830. THERMIONIC AMPLIFIERS. H. D. Arnold. (*British Patent 141033*, March 24th, 1920. Convention date, March 28th, 1919. Patent not yet accepted but open to inspection.)

This specification provides for an arrangement of a multi-stage triode amplifier so that the ratio of amplification may be varied without varying the impedance offered by the amplifier as a whole to the impulse to be amplified. The arrangement described is identical with that enclosed between the dotted lines in the centre of Fig. 7 above. The ratio of amplification may be varied by means of the potentiometer resistance P (of about 500,000 ohms) which is connected between the output of the first valve V_3 and the input of the second valve V_4 . The battery B_3 serves to maintain the grid of V_4 at a negative potential so that the valve offers a substantially infinite impedance to incoming impulses. The two valves may be supplied from the common H.T. battery B_2 through the choking inductance shown.

831. SOME OF THE PROBLEMS OF ATMOSPHERIC ELIMINATION IN WIRELESS RECEPTION. P. R. Coursey. (*Wireless World*, 8, pp. 191—201, June 12th, 1920; and pp. 225—234, June 26th, 1920. *Technical Review*, 6, p. 659, August 3rd, 1920—Abstract.)

Paper read before the Wireless Society of London, together with verbatim report of the discussion—see RADIO REVIEW, 1, p. 492, July, 1920, for abstract.

* See also RADIO REVIEW Abstract No. 8.

832. THE USE OF GROUND WIRES AT REMOTE CONTROL STATIONS. A. H. Taylor and H. Crossley. (*Proceedings of the Institute of Radio Engineers*, 8, pp. 171—192, January, 1920.)

The investigations of A. H. Taylor* have shown that a subterranean receiving system possesses many important advantages, e.g., high degree of directivity and immunity from atmospherics. By utilising this directional selectivity it has been found possible to install receiving stations in the immediate vicinity of transmitting systems. The installation of such "remote" control stations at Great Lakes, Norfolk and New Orleans is described. The first station may be taken as typical. At this station there are two transmitting antennæ, the lower for spark working (600 to 1,500 metres) and the upper for spark (1,500 to 3,400 metres) and arc (3,000 to 10,000 metres) working. The subterranean receiving station was built only 600 feet from the nearest tower of the transmitting station. The actual receiving tent was carefully covered with wire screening. A very small crack in the door of the screen cage would admit sufficient energy from the neighbouring transmitter to interfere with the reception of distant signals. The actual ground wires were laid as nearly as possible at right angles to the direction of the transmitter. There was however some small deviation from this right-angled relationship so that signals especially on certain wavelengths penetrated to the receiver. It was found possible to eliminate this by using a very small loop in series with one of the ground wires and placed outside the receiving tent. The loop could be rotated until minimum interference was obtained. The use of the loop was only necessary when transmitting and receiving on identical wavelengths.

It was found that the electrical impulses which the ground wires pick up are not nearly as strong as might be expected from the close proximity of the transmitter. This is attributed to the fact that the waves must travel some distance before they obtain the necessary forward slant which makes ground wire reception possible.

A detailed description of the design and lay-out (including telephone connections between transmitting and receiving stations) of the Great Lakes station is given.

In the discussion J. Mills emphasised the necessity for the quantitative comparison of receiving stations with reference to their efficiency in reducing the effects of strays and interfering signals. A rough outline of such a method was also given.

833. FRAME AERIALS. A. Esau. (*Telefunken Zeitung*, 3, No. 18, pp. 51—59, October, 1919.)

A description of many forms of frame aerials, small portable ones, collapsible ones, and large ones supported on masts; their advantages and special characteristics are discussed.

834. AERIALS: DUPLEX SIGNALLING. H. J. J. M. de R. de Bellescize. (*French Patent* 501428, November 7th, 1918. Published April 14th, 1920.)

This specification describes a system of duplex wireless telegraphy. For further particulars, see British Patent 136524.†

835. AERIALS FOR WIRELESS SIGNALLING. J. H. Rogers. (*British Patent* 137511, November 20th, 1919. Convention date, January 10th, 1919. Patent accepted March 11th, 1920.)

An arrangement of aerial is described as being suitable for use on a submarine. Two wires are stretched out longitudinally above the vessel one running forward and the other aft, and are led in through insulators in the conning tower. The ends of the wires are connected to the hull of the vessel at each end, and a tuning condenser is inserted between the adjacent ends of the wires inside the vessel so as to form a loop aerial which may be connected to the transmitting and receiving apparatus in the usual manner.‡

* See RADIO REVIEW Abstracts No. 149, January, 1920, and No. 313, April, 1920.

† RADIO REVIEW Abstract No. 493, July, 1920.

‡ See also RADIO REVIEW Abstract No. 85, December, 1919.

836. ELECTRICAL ENGINEERING IN 1919—WIRELESS TELEGRAPHY AND TELEPHONY. (*Engineer*, 129, p. 9, January 2nd, 1920.)

A very brief *resumé* of the chief lines of radio progress during 1919.

837. THE ROME RADIO STATION OF THE ITALIAN NAVY. C. F. Elwell. (*Proceedings of the Institute of Radio Engineers*, 8, pp. 193—198, June, 1920.)

Describes in detail the arc station at Rome built rapidly during the war to cope with traffic from Italy to America and to the Italian colonies in Africa.

The following is a brief summary of the details :—Range of station 4,200 miles ; antenna of triangular type 714 feet high ; antenna capacity 0.011 mfd. ; arc generator rated at 200 kW. (250 amperes at 800 volts).

838. THE GERMAN IMPERIAL WIRELESS NETWORK. (*Telefunken Zeitung*, 4, No. 20, pp. 15—16, May, 1920. Also *Electrician*, 83, p. 114, July 23rd, 1920—Abstract.)

Particulars are given of the German network of radio stations with a map showing those in use and those under construction.

839. THE INTERNAL AND INTERNATIONAL ORGANISATION AND DEVELOPMENT OF GERMAN WIRELESS IN SHIPPING. F. H. Quiring. (*Telefunken Zeitung*, 4, No. 20, pp. 23—34, May, 1920.)

An abstract from a thesis for the doctor degree.

840. THE RADIOTELEGRAPHIC STATION AT ROME (SAN PAOLO). B. Micchiardi, G. Pession, and G. Vallauri. (*L'Elettrotecnica*, 7, pp. 218—224, May 5th, 1920, and pp. 241—244, May 15th, 1920 ; and also Editorial Notes on pp. 217 and 237. Also *Electrical World*, 75, p. 1207, May 22nd, 1920—Abstract.)

See Abstract No. 538, July, 1920, where a translation of this article has already been abstracted.

841. THE WIRELESS STATION AT WARSAW. (*La T.S.F. Moderne*, 1, pp. 7—11, April, 1920.)

A short illustrated description giving details of the 12 kW. Telefunken station captured from the Germans by the Polish Army.

842. FRENCH RADIO STATION TO HAVE 13,000-MILE RANGE. (*Electrical Experimenter*, 7, p. 110, March, 1920.)

A few brief notes relative to the Bordeaux station. 500 kW. is to be provided in the antenna and the station is to be capable of sending 72,000 words per day.

843. VALVE RADIOTELEGRAPHIC STATIONS. C. Gutton. (*La T.S.F. Moderne*, 1, pp. 32—40, May, 1920.)

This article deals with the arrangement of simple valve transmitting and receiving stations. For transmitting two valves are employed connected in parallel with an ordinary arrangement of inductive reaction coupling. For receiving a three-valve arrangement is described with inductive coupling to the aerial circuit, the first valve acting as detector and the other two as low frequency amplifiers. The complete connection scheme for the whole station is given and simple methods of adjusting the apparatus for wavelength, power, etc., are also dealt with. The station described is similar to arrangements developed in the French military radiotelegraphic laboratories.

844. INDUCTANCES. R. F. Gowen. (*British Patent* 141344, April 1st, 1920. Convention date, April 4th, 1919. Patent not yet accepted but open to inspection.)

This specification covers the construction of inductances with spaced windings similar to the so-called "honeycomb" pattern of coil. This construction reduces the self capacity of the winding.

845. THE CONSTRUCTION OF HONEYCOMB INDUCTANCES. H. R. Moore. (*Electrical Experimenter*, 7, p. 1160, March, 1920.)
The construction of a simple machine for winding these coils is described.
846. NAUEN. E. Quack. (*Telefunken Zeitung*, 3, No. 17, pp. 20—26, August, 1919.)
A general illustrated description of the rise and development of Nauen Wireless Station.
847. NAUEN DURING THE WAR. B. Schuchardt. (*Telefunken Zeitung*, 3, No. 17, pp. 27—29, August, 1919.)
A popular account of the development of Nauen during the war.
848. THE NAUEN TOWERS. F. Brückerbohm. (*Telefunken Zeitung*, 3, No. 17, pp. 51—60, August, 1919.)
A well-illustrated descriptive article.
849. THE ERECTION OF THE NEW BUILDINGS OF THE NAUEN STATION DURING THE WAR. H. Rabes. (*Telefunken Zeitung*, 3, No. 17, pp. 46—50, August, 1919.)
A well-illustrated descriptive article.
850. VARIABLE INDUCTANCE. H. P. Donle. (*U.S. Patent* 1332453, December 15th, 1917. Patent granted March 2nd, 1920.)
The arrangement described provides for the means of moving two coils relative to one another so as to vary their mutual inductance, and a switch to automatically change the connections so that the windings assist or oppose one another in order to obtain a continuous range of variation of the inductance of the whole.
851. THE DISTANT CONTROL OF ELECTRICAL APPARATUS. Chauveau. (*Bulletin Officiel de la Direction des Recherches et Inventions*, No. 3, pp. 179—186, January, 1920. *Revue Générale de l'Électricité*, 7, p. 156D, May 15th, 1920—Abstract.)
An electrical apparatus suitable for control either by wire or wireless is described.
852. THE EFFECT OF RAREFIED ATMOSPHERE ON SPARK TRANSMITTERS. F. Jentzch-Graefe. (*Fahrbuch Zeitschrift für drahtlose Telegraphie*, 15, pp. 311—317, April, 1920.)
Numerous reports from the German front have indicated that frequently radio-transmission was not possible with the earth from heights of over 6,000 metres. The problem thus presented has been investigated by laboratory methods using a German D type transmitter. The influence of an extremely low temperature was studied by maintaining the temperature of the transmitter and complete valve receiver at -40° C. The wavelength and decrement of the transmitter were unaltered and only small variations were noted in the amplifier battery voltage. The influence of the reduction in pressure was next studied, the spark gap being enclosed in a chamber from which the air could be pumped. The relation between antenna current and pressure was determined. It was found that the antenna current very gradually diminished until the pressure was 360 mm. below normal, but that between this pressure and 430 mm. below normal the current dropped rapidly (*e.g.*, in one case from 0.62 amps. to 0.1 amps.). For pressures lower than this the antenna current remained extremely small resulting of course in weak radiation. The pressures mentioned, 360 mm. to 430 mm. below normal, correspond to heights of 5,500 metres to 6,500 metres.
853. IS WIRELESS TELEGRAPHY SUITABLE AS A MEANS OF COMMUNICATION IN LARGE ELECTRIC POWER DISTRIBUTION SYSTEMS? G. Schmidt. (*Telegraphen- und Fernsprech-Technik*, 9, pp. 16—17, April, 1920.)
A discussion of the advantages and disadvantages of wireless as compared with ordinary

line telephony. He finally recommends the use of the overhead power lines as guides for what would otherwise be a wireless telephone system.

854. MULTIPLEX TELEPHONY AND TELEGRAPHY WITH OPEN-CIRCUIT BARE WIRES. G. O. Squier. (*Journal of the Franklin Institute*, 189, pp. 693—714, June, 1920. *Electrician*, 84, pp. 641—643, June 11th, 1920—Abstract. *Times Engineering Supplement*, No. 547, p. 173, May, 1920—Abstract. *Electrical Review*, 86, p. 592, May 7th; pp. 710—711, June 4th, 1920—Abstract. *Electrical World*, 75, p. 1020, May 1st, 1920—Abstract. *Telegraph and Telephone Age*, 38, pp. 384—390, July 16th, 1920, and pp. 417—420, August 1st, 1920—Abstract. *Wireless Age*, 7, pp. 20—21, July, 1920—Abstract.)

Refers to the use of high frequency alternating current for communication along bare wires laid in sea water. Frequencies of 600,000 and 1,000,000 have been used in experiments with transmitting currents up to 270 milliamps.

For reception a triode detector and amplifier was used as a potentially operated receiver, leaving the usual earth connection open.

The article also refers to a new type of radiogoniometer for determining absolute directions in which use is made of a long helix on which stationary waves are set up. One end of the helix is earthed and the point of highest potential connected to the grid of the triode detector.

855. INTERPLANETARY WIRELESS. Q. Majorara. (*L'Elettrotecnica*, 7, pp. 198—200, April 25th, 1920.)

A discussion of the possibility of signals from Mars or other planets.

856. INTERPLANETARY COMMUNICATION. C. S. Brainin. (*Electrical Experimenter*, 7, p. 641, November, 1919.)

Discussion of the possibilities of communication with other planets.

857. RADIO FREQUENCY CURRENTS ON WIRES. J. O. Mauborgne. (*Electrical Experimenter*, 7, p. 1156, March, 1920.)

See RADIO REVIEW Abstracts No. 565, July, 1920, and No. 175, January, 1920, for abstract of articles covering the same subject-matter. This particular account includes an illustration of the apparatus used in the first "wired-wireless" tests in Canada in May, 1919, between Toronto and Hamilton over a distance of forty to forty-five miles.

858. AMPLIFYING APPARATUS. Société le Matériel Téléphonique. (*French Patent* 500654, June 12th, 1919. Published March 20th, 1920.)

The invention relates to apparatus for signalling at high frequency. For further particulars, see British Patent 130432.*

2. Books.

LEÇONS DE PHYSIQUE GÉNÉRALE. By J. Chappuis and A. Berget. Vol. II. Électricité et Magnétisme. Revised by J. Chappuis and M. Lamotte. (Paris: Gauthier Villars et Cie. Third Edition, 1920. Pp. 623. Price 45 fr.)

This third edition of the well-known text-book of physics has been completely revised and rewritten by Chappuis and Lamotte. It is intended to cover the course followed at the École Centrale des Arts et Manufactures by

* RADIO REVIEW Abstract No. 294, April, 1920.

the candidates for the Licence ès Science Physique. It presupposes more than an elementary knowledge of mathematics as the first section deals with potential theory and introduces partial differentials, direction cosines, Poisson's equation, etc. On the descriptive and experimental side, however, it presupposes very little, if any, previous knowledge. It deals not only with pure physics but with such applications as polyphase currents and star and mesh connection, although, of course, such things are not considered at any length. There is a chapter on industrial electrical measuring instruments.

G. W. O. H.

WIRELESS TELEGRAPHY AND TELEPHONY: First Principles, Present Practice and Testing. By H. M. Dowsett, M.I.E.E. (London: *The Wireless Press, Ltd.* 1920. Pp. xxxi. + 331. Price 9s. net.)

One feature of this book which might with advantage be copied in many others is the table of symbols on p. 1 which are to be used in the interpretation of the drawings. It would be a good thing if some international agreement could be reached on this subject, as it would save both time and trouble for those who have to deal with the voluminous literature which is now available in wireless telegraphy. The book opens, as a good many other books on this subject do nowadays, with a chapter on the nature of electricity and the atom. It is a good thing that the electrician of to-day should be more fully acquainted than his predecessors were with the nature of the forces with which he is dealing, but one is inclined to doubt whether any great advantage is to be gained by the person for whom this book is intended by a study of the very ingenious models which the author has devised, showing atomic structure. They are hardly consistent with the structure that distinguished physicists like Rutherford and Bohr have postulated, and though one does not wish to claim a monopoly of physical knowledge for the professional physicists, it would perhaps have been better if speculations so doubtful in their validity as to the form and structure of the atom had been omitted. The same criticism applies to the highly problematical structure of the ether during the process of the generation of the magnetic field. On the other hand, the very praiseworthy efforts made later in the book to give some physical conception of what really happens when electro-magnetic waves are "whipped off" a radiator, is deserving of commendation. Very little has been written on this subject since Hertz's original experiments, and the suggestion of the electrons carrying the ends of lines of electric force as they oscillate backwards and forwards on a radiator, and of the lines of force automatically, as it were, becoming detached from the oscillator when their ends cross gives a valuable mental picture which should help the student to understand what is really happening when an oscillator is producing a train of electric waves. One criticism should be made here which it is hoped will lead to correction. All the vector diagrams are shown with the vectors rotating clockwise. It has now been agreed by the International Electro-Technical Commission that the standard direction of rotation should be counter-clockwise.

The chapter on the spark discharge is very good. The methods of adjusting the Marconi spark discharger and the theoretical discussion of its working are of great interest and should be most valuable to those who are using this type of apparatus. There is also a description of the quenched spark system used by the Marconi Company, and the principles of this also are discussed. There is a most valuable description in the next chapter of the various forms of continuous wave transmitter. Not only are the well-known alternators devised by Alexanderson and Goldschmidt described, but the high frequency generator used by the French radio engineers is explained, as well as the various types of static transformer frequency changers which have been in use at the German continuous wave stations at Nauen and elsewhere. The Marconi timed spark system which has been employed so successfully at Carnarvon is explained, and a full account given of the 25 kW. Marconi-Poulsen arc generator with all its improvements.

The following chapter (V.) deals with thermionic valves; it is somewhat marred by a very imaginative account of the movement of secondary electrons in atoms which are interchanging electrons. The description, however, of the various types of valves and valve circuits is excellent. The arrangement of valve circuits to give retroaction, amplification and heterodyning is exceedingly full and clear, and to any one interested in the practical use of valves (and that nowadays includes every radio engineer), the descriptions will be of the greatest possible assistance. At the end of the chapter an account is given of valve telephone circuits and of some of the methods used in wireless telephony. The great merit of this part of the book is that it is so evidently the work of one who has had the practical handling of the apparatus, and who, at the same time, understands the principle of action of the gear with which he has to deal. There is a short account of high speed telegraph apparatus (including the Einthoven galvanometer) used for automatic recording.

In the next few chapters a short account is given of the methods of measuring current, potential difference and resistance. In the chapter dealing with measurement of capacity, there is a very good description of the methods of finding accurately at high frequency the value of the capacity of the small condensers with which the wireless engineer has usually to deal; an equally useful chapter describes the methods of measuring inductance. The chapter on measurement of frequency is one of the best in the book. Not only are the better known methods of measuring low frequencies described, but the determination of high frequencies by photography of the spark and the method of spark counting by dictaphone are explained. The arrangement of the Lecher wire system for calibrating wavemeters and other methods of wavemeter calibration are mentioned. A very good account of the determination of dielectric strength is given in Chapter XII. including the arrangement of spherical electrodes used by the National Physical Laboratory and its limitations, and a useful table of sparking voltages between needle points and balls is included. The methods used for testing insulators and bushings are also explained. The measurement of decrement forms the subject of the next chapter, which is also very full and

complete, and in this is contained an account of the determination of the decrement due to the resistance of the spark. The fact that the decrement in a spark circuit is not constant but increases as the spark dies away is here stated; a fact of great importance. Very few measurements of spark resistance have been published, and the subject is one that deserves further study. The measurement of the decrement of coupled circuits and of the Marconi decimeter are described, the chapter concluding with an account of the determination of the decrement of antennæ, due to radiation, brushing, dielectric hysteresis, eddy currents, ohmic resistance and earth resistance. The last chapter deals with direction finding and the measurement of signal strength. This book is one which will prove of great value to every practical radio engineer, it is the work of an expert in the operation of wireless apparatus, and is full of information which hitherto has not been available in so compact and convenient a form.

E. W. MARCHANT.

THE PRACTICAL ENGINEER'S ELECTRICAL POCKET BOOK AND DIARY FOR 1920. (London: *The Technical Publishing Co., Ltd.* Pp. clxiv. + 592 + 56 (Diary). Price 1s. 6d. net; best cloth binding 2s. net.)

This pocket book contains the usual collection of mathematical and electrical tables with explanatory notes arranged for handy reference, and also a number of sections each devoted to a particular branch of electrical work. These sections on the whole contain a quantity of handy and valuable information, but amongst them is one entitled "Wireless Telegraphy," in which a very brief *résumé* is given of the action of a transmitter using the spark system. The only diagram given, however, is that of an obsolescent arrangement using a magnetic detector, while more modern apparatus is hardly mentioned. A statement is also noticed to the effect that a valve detector is connected *in series* with the oscillatory circuit. Some reference to more modern wireless books than those quoted would be useful in this section. A diary and Buyers' Dictionary in three languages concludes the book.

P. R. C.

Books Received.

INTRODUCTION À LA THÉORIE DES COURANTS TÉLÉPHONIQUES ET DE LA RADIO-TÉLÉGRAPHIE. By J. B. Pomey with a Preface by A. Blondel. (Paris: *Gauthier-Villars et Cie.*, 1920. Pp. xiv + 510. Price 50 frs.)

WORKING DIAGRAM OF VALVE AMPLIFYING RECEIVER CIRCUITS. By H. W. Sullivan. (London: *H. W. Sullivan*, 1920. Pp. 24. Price 1s.)

A New Dutch Radio Society.

The Nederlandsch Radio Genootschap was founded on May 29th, at Amsterdam, under the direction of Professor G. J. Elias as chairman, and Dr. Balth van der Pol as vice-chairman. The Society aims to be the centre of scientific radio work in Holland. The address of the Society's offices is W. Barentzstraat, 8, Utrecht, the secretary being Ir. H. Nordlohne.

Messrs. Vickers, Ltd., Broadway, London, S.W. 1, inform us that they have opened a dépôt for Wales and the south-west of England at 43, Park Street, Bristol, at which address they will be glad to receive enquiries for their products.